



THE CITY OF WINNIPEG

TENDER

TENDER NO. 511-2021

**PROVISION OF HOURLY RATES – HIRED EQUIPMENT AND DUMP TRUCKS 2021-
2022 SNOW SEASON**

IMPORTANT NOTICE TO BIDDERS

NOTICE #1 - INFORMATION MEETING ABOUT TENDER NO. 511-2021 FOR THE PROVISION OF HOURLY RATES FOR HIRED EQUIPMENT AND DUMP TRUCKS FOR THE 2021-2022 SNOW SEASON. The Heavy Equipment & Aggregate Truckers Association of Manitoba Inc. (HEAT) have made arrangements to hold a virtual information meeting that will take place on August 11th at 7:00 PM. To register please RSVP to memberservices@heatmb.ca or by calling Shannon at 204-809-0142. City representatives will be available to provide an update about changes for this upcoming winter season.

NOTICE #2 - IN THE PROVISION OF GUARANTEED EQUIPMENT OF THIS TENDER, THE HIGHEST SLOTTING ADVANTAGE WILL BE GIVEN TO CURRENT YEAR MODELS WITH SUPPLIED SERIAL NUMBERS IN ALL CLASSES (J3, J5 AND K6). IN THE EVENT THAT A CONTRACTOR DOES SUPPLY A 2022 (FUTURE) MODEL WITH A SERIAL NUMBER, IT WILL BE SLOTTED ALONG WITH THE 2021 MODELS AND WILL BE GIVEN NO ADDITIONAL SLOTTING ADVANTAGE.

ALL CHANGES MADE TO THIS TENDER FROM THE PREVIOUS (507-2020 TENDER) ARE HIGHLIGHTED IN YELLOW.

OPERATOR BEST PRACTICES GUIDELINES

The City of Winnipeg Snow Clearing Best Practices Guidelines is an online orientation that has the objective to educate and increase operator knowledge on how to best perform street snow clearing work on City right-of-way. The online orientation is a joint venture between the City of Winnipeg Streets Maintenance Division and the Heavy Equipment & Aggregate Trucker Association (HEAT).

All operators of truck plows, graders, loaders and sidewalk clearing equipment are required to complete the City of Winnipeg Snow Clearing Best Practices Online Orientation and have a certificate of completion in possession when reporting to work for the City. Operators **MUST** have completed the course prior to working their first shift and are expected to be able to produce a paper or digital copy of the certificate to the City Of Winnipeg Foreman who they report to.

Access to the online orientation can be found at www.citysnowremoval.ca. The site will be under construction this summer. Upon completion, registered group leaders will be informed by email as to how these changes will affect usage. Companies can purchase multiple seats to their account or have their operators purchase them individually. Cost is \$40.00 per course and certificates are valid for 2 years. H.E.A.T. Members receive a discounted price of \$25.00. Each user must have their own email address. Please contact memberservices@heatmb.ca for all questions regarding member pricing or to be assigned your discount.

For any assistance with the website, technical difficulties or accessing your certificate please email admin@citysnowremoval.ca or call 204-809-0142.

NOTICE #3 – NEW CLASSES HAVE BEEN ADDED AT E4 AS WELL AS AT E7.

TABLE OF CONTENTS

PART A - BID SUBMISSION

- Form A: Bid/Proposal
- Form B: Prices

PART B - BIDDING PROCEDURES

B1. Contract Title	1
B2. Submission Deadline	1
B3. Information Meeting	1
B4. Enquiries	1
B5. Confidentiality	1
B6. Addenda	2
B7. Substitutes	2
B8. Bid Submission	3
B9. Bid	4
B10. Prices	4
B11. Disclosure	6
B12. Provision for Guaranteed Equipment	6
B13. Conflict of Interest and Good Faith	7
B14. Qualification	8
B15. Opening of Bids and Release of Information	9
B16. Irrevocable Bid	9
B17. Withdrawal of Bids	9
B18. Evaluation of Bids	9
B19. Award of Contract	10

PART C - GENERAL CONDITIONS

C0. General Conditions	1
------------------------	---

PART D - SUPPLEMENTAL CONDITIONS

General

D1. General Conditions	1
D2. Scope of Work	1
D3. Definitions	1
D4. Contract Administrator	1
D5. Contractor's Supervisor	1
D6. Notices	2

Submissions

D7. Authority to Carry on Business	2
D8. Workers Compensation	2
D9. Insurance	2
D10. Damage Claims	3

Schedule of Work

D11. Commencement	4
D12. Declaration by Contractor	4
D13. Equipment and Truck Reliability	4
D14. COVID-19 Schedule Delays	5
D15. Operator's Competence and Performance	5
D16. Operator Best Practices Guidelines	5
D17. Suspension and Removal from Callout Lists	6

Control of Work

D18. Owners of Equipment/Trucks and their Employees	7
D19. Safety Requirements	7
D20. Equipment Identification	8
D21. Winnipeg Climate Action Plan and Annual Fuel Reporting	8

Measurement and Payment

D22. Work Tickets	9
D23. Substitutions, Replacement and Availability	9
D24. Withdrawal of Equipment/Trucks Prior to Layoff	10
D25. Re-Arrangement of Hired Equipment and Trucks	10
D26. Contractor's Office and Telephone Numbers	11
D29. Payment	12
D30. Rate Adjustments – Fuel Costs	13
D31. Basis for Hiring and Layoff	14

PART E - SPECIFICATIONS

General

E1. Applicable Specifications and Drawings	1
E2. Semi-Trailer Trucks	1
E3. Hydraulic Excavators	1
E4. Crawler Tractor/Dozer	2
E5. Rubber Tracked Crawler Tractor	3
E6. Rubber-Tired Front End Loader	3
E7. Rubber-Tired Skid Steers and Trackless Tractors	4
E8. Motor Grader	5
E9. Truck-Mounted Snow Plow	5
E10. Truck-Mounted Street Sander – (Minimum 6 CU.YD/4.6 CU.M)	5
E11. Truck-Mounted Street Sander With Computerized Spreader Controls	5
E12. Snow Blowers	6
E13. Truck or Trailer Mounted De-Icer/Flusher	6

APPENDICES

Appendix A – Streets Maintenance Division	1
Appendix B – Work Ticket Sample	1
Appendix C – Equipment Lighting and Visibility Requirement	1

PART B - BIDDING PROCEDURES

B1. CONTRACT TITLE

B1.1 PROVISION OF HOURLY RATES-HIRED EQUIPMENT AND DUMP TRUCKS 2021-2022 SNOW SEASON

B2. SUBMISSION DEADLINE

B2.1 The Submission Deadline is 4:00 p.m. Winnipeg time, August 24, 2021.

B2.2 The Contract Administrator or the Manager of Materials may extend the Submission Deadline by issuing an addendum at any time prior to the time and date specified in B2.1.

B3. INFORMATION MEETING

B3.1 Further to C3.1, the Contract Administrator or an authorized representative will be available at a Information Meeting that will be held by HEAT virtually on August 11, 2021 at 7:00 PM.

B3.1.1 People interested in joining should RSVP prior to Friday, August 6th to register at memberservices@heatmb.ca or by calling Shannon at 204-809-0142

B3.2 The Bidder shall not be entitled to rely on any information or interpretation received at the Information Meeting unless that information or interpretation is provided by the Contract Administrator in writing.

B4. ENQUIRIES

B4.1 All enquiries shall be directed to the Contract Administrator identified in D4.1.

B4.2 If the Bidder finds errors, discrepancies or omissions in the Tender, or is unsure of the meaning or intent of any provision therein, the Bidder shall promptly notify the Contract Administrator of the error, discrepancy or omission at least five (5) Business Days prior to the Submission Deadline.

B4.3 Responses to enquiries which, in the sole judgment of the Contract Administrator, require a correction to or a clarification of the Tender will be provided by the Contract Administrator to all Bidders by issuing an addendum.

B4.4 Responses to enquiries which, in the sole judgment of the Contract Administrator, do not require a correction to or a clarification of the Tender will be provided by the Contract Administrator only to the Bidder who made the enquiry.

B4.5 The Bidder shall not be entitled to rely on any response or interpretation received pursuant to B4 unless that response or interpretation is provided by the Contract Administrator in writing.

B4.6 Any enquiries concerning submitting through MERX should be addressed to:

MERX Customer Support
Phone: 1-800-964-6379
Email: merx@merx.com

B5. CONFIDENTIALITY

B5.1 Information provided to a Bidder by the City or acquired by a Bidder by way of further enquiries or through investigation is confidential. Such information shall not be used or disclosed in any way without the prior written authorization of the Contract Administrator. The use and disclosure of the confidential information shall not apply to information which:

- (a) was known to the Bidder before receipt hereof; or
- (b) becomes publicly known other than through the Bidder; or

(c) is disclosed pursuant to the requirements of a governmental authority or judicial order.

B5.2 The Bidder shall not make any statement of fact or opinion regarding any aspect of the Tender to the media or any member of the public without the prior written authorization of the Contract Administrator.

B6. ADDENDA

B6.1 The Contract Administrator may, at any time prior to the Submission Deadline, issue addenda correcting errors, discrepancies or omissions in the Tender, or clarifying the meaning or intent of any provision therein.

B6.2 The Contract Administrator will issue each addendum at least two (2) Business Days prior to the Submission Deadline, or provide at least two (2) Business Days by extending the Submission Deadline.

B6.3 Addenda will be available on the **MERX website at www.merx.com**.

B6.4 The Bidder is responsible for ensuring that he/she has received all addenda and is advised to check the **MERX** website for addenda regularly and shortly before the Submission Deadline, as may be amended by addendum.

B6.5 The Bidder shall acknowledge receipt of each addendum in **Paragraph 10 of Form A: Bid/Proposal**. Failure to acknowledge receipt of an addendum may render a Bid non-responsive.

B6.6 Notwithstanding B4, enquiries related to an Addendum may be directed to the Contract Administrator indicated in D4.

B7. SUBSTITUTES

B7.1 The Work is based on the Plant, Materials and methods specified in the Tender.

B7.2 Substitutions shall not be allowed unless application has been made to and prior approval has been granted by the Contract Administrator in writing.

B7.3 Requests for approval of a substitute will not be considered unless received in writing by the Contract Administrator at least five (5) Business Days prior to the Submission Deadline.

B7.4 The Bidder shall ensure that any and all requests for approval of a substitute:

- (a) provide sufficient information and details to enable the Contract Administrator to determine the acceptability of the Plant, Material or method as either an approved equal or alternative;
- (b) identify any and all changes required in the applicable Work, and all changes to any other Work, which would become necessary to accommodate the substitute;
- (c) identify any anticipated cost or time savings that may be associated with the substitute;
- (d) certify that, in the case of a request for approval as an approved equal, the substitute will fully perform the functions called for by the general design, be of equal or superior substance to that specified, is suited to the same use and capable of performing the same function as that specified and can be incorporated into the Work, strictly in accordance with the proposed work schedule and the dates specified in the Supplemental Conditions for Total Performance;
- (e) certify that, in the case of a request for approval as an approved alternative, the substitute will adequately perform the functions called for by the general design, be similar in substance to that specified, is suited to the same use and capable of performing the same function as that specified and can be incorporated into the Work, strictly in accordance with the proposed work schedule and the dates specified in the Supplemental Conditions for Total Performance.

- B7.5 The Contract Administrator, after assessing the request for approval of a substitute, may in his sole discretion grant approval for the use of a substitute as an “approved equal” or as an “approved alternative”, or may refuse to grant approval of the substitute.
- B7.6 The Contract Administrator will provide a response in writing, at least two (2) Business Days prior to the Submission Deadline, to the Bidder who requested approval of the substitute.
- B7.6.1 The Contract Administrator will issue an Addendum, disclosing the approved materials, equipment, methods and products to all potential Bidders. The Bidder requesting and obtaining the approval of a substitute shall be responsible for disseminating information regarding the approval to any person or persons he/she wishes to inform.
- B7.7 If the Contract Administrator approves a substitute as an “approved equal”, any Bidder may use the approved equal in place of the specified item.
- B7.8 If the Contract Administrator approves a substitute as an “approved alternative”, any Bidder bidding that approved alternative may base his Total Bid Price upon the specified item but may also indicate an alternative price based upon the approved alternative. Such alternatives will be evaluated in accordance with B18.
- B7.9 No later claim by the Contractor for an addition to the Total Bid Price because of any other changes in the Work necessitated by the use of an approved equal or an approved alternative will be considered.

B8. BID SUBMISSION

- B8.1 The Bid shall consist of the following components:
- (a) Form A: Bid/Proposal;
 - (b) Form B: Prices;
 - (i) Snow Removal Equipment; and/or
 - (ii) Semi-Trailer Dump Trucks; and/or
 - (iii) Rubber Tired Skid Steer.
- B8.1.1 When Bidding equipment in the J10, J11, J13, J14, J15, J16, J17, J18 classes, enter Bids on Form B: Prices with the heading: RUBBER-TIRED SKID STEER AND TRACKLESS TRACTORS.
- B8.1.2 Place a check mark as required on Form B: Snow Removal Equipment if interested in providing Guaranteed Equipment.
- B8.1.3 The City of Winnipeg is interested in entering into an agreement for the guaranteed provision of a limited number of loaders and graders for the 2021/2022 winter season. Bidders who may be interested in making such a commitment to the City must complete Form B: if a unit is not indicated for the guaranteed list on Form B:, it will not be considered to be applying for the guaranteed list.
- B8.2 All components of the Bid shall be fully completed or provided, and submitted by the Bidder no later than the Submission Deadline, with all required entries made clearly and completely.
- B8.3 Bidders must enter all requested information accurately. Corrections will not be allowed after the Submission Deadline. The City intends to perform random audits to verify the accuracy of the information provided. Units found to be misrepresented as to type or age will be removed from the Hired Equipment list for the duration of the Contract and further may affect the ability of the Bidder to qualify for future Contracts. All equipment listed without a class, will be entered in the W1 Non Bid Class.
- B8.4 The Bid shall be submitted electronically through MERX at www.merx.com.
- B8.4.1 Bids should be submitted in Microsoft Excel format.

B8.5 Bidders are advised that inclusion of terms and conditions inconsistent with the Tender document, including the General Conditions, will be evaluated in accordance with B18.1(a).

B9. BID

B9.1 The Bidder shall complete Form A: Bid/Proposal, making all required entries.

B9.2 Paragraph 2 of Form A: Bid/Proposal shall be completed in accordance with the following requirements:

- (a) if the Bidder is a sole proprietor carrying on business in his own name, his name shall be inserted;
- (b) if the Bidder is a partnership, the full name of the partnership shall be inserted;
- (c) if the Bidder is a corporation, the full name of the corporation shall be inserted;
- (d) if the Bidder is carrying on business under a name other than his own, the business name and the name of every partner or corporation who is the owner of such business name shall be inserted.

B9.2.1 If a Bid is submitted jointly by two or more persons, each and all such persons shall identify themselves in accordance with B9.2.

B9.3 In Paragraph 3 of Form A: Bid/Proposal, the Bidder shall identify a contact person who is authorized to represent the Bidder for purposes of the Bid.

B9.4 **Paragraph 13 of Form A: Bid/Proposal** shall be signed in accordance with the following requirements:

- (a) if the Bidder is a sole proprietor carrying on business in his own name, it shall be signed by the Bidder;
- (b) if the Bidder is a partnership, it shall be signed by the partner or partners who have authority to sign for the partnership;
- (c) if the Bidder is a corporation, it shall be signed by its duly authorized officer or officers;
- (d) if the Bidder is carrying on business under a name other than his own, it shall be signed by the registered owner of the business name, or by the registered owner's authorized officials if the owner is a partnership or a corporation.

B9.4.1 The name and official capacity of all individuals signing Form A: Bid/Proposal should be entered below such signatures.

B9.5 If a Bid is submitted jointly by two or more persons, the word "Bidder" shall mean each and all such persons, and the undertakings, covenants and obligations of such joint Bidders in the Bid and the Contract, when awarded, shall be both joint and several.

B10. PRICES

B10.1 The Bidder shall state the Make, Model, Unit Number and Serial Number to identify all equipment and trucks **electronically** on Form B: Prices. Failure to include the Make, Model, Unit Number and Serial Numbers shall cause the equipment to be rejected. Only original equipment manufactured (O.E.M.) serial number to be used. Failure to include the Make, Model, and Unit Number shall cause the equipment or truck to be rejected.

B10.1.1 For the convenience of the Bidders and for functional and clarity purposes, **the Bidder shall enter the required information on all forms in electronic format.** An electronic document of Form B: Prices in Microsoft Excel format is available with documents for this Tender on **MERX website at: www.merx.com.**

B10.2 Bidders may be required to submit a copy of the vehicle registration after the submission deadline. No truck shall be call out for Work until the vehicle registration has been submitted if required.

- B10.3 In the event that Bids from different Bidders are identical for a class, the City reserves the right to have a lottery. The lottery would consist of having a draw of names to set the call-out order, with all tied Bidders being invited to attend.
- B10.4 In the event that the City errors in slotting and/or calling out of equipment/trucks, the Bidder/Contractor shall have no claim against the City.
- B10.5 The Contractor shall not be compensated for rest breaks or meal breaks except as outlined below. If operational requirements permit, the City foreman may, at his discretion, allow one (1) paid break per four (4) hours of Work up to the maximum extent of fifteen (15) minutes. The fifteen (15) minutes for the break shall include travel time to and from the Work site. Breaks cannot be accumulated nor will payment be owing by the City for breaks not granted or taken.
- B10.6 All quoted hourly rental rates shall include all costs of any nature whatsoever associated with the supply and operation of the equipment and trucks, including but not limited to:
- (a) qualified and competent operators;
 - (b) fuel, oil, lubrication and all maintenance;
 - (c) any and all overtime, except as specified in B10.10 (i.e. no special or additional rates will be accepted);
 - (d) any and all travel time to the Work site, except as specified in B10.5; and
 - (e) all insurance and other costs.
- B10.7 Sander license plate number to be used instead of unit number.
- B10.8 All sanders shall Bid on a per hour basis for each area. (North, East, South)
- B10.9 For slotting purposes, the Rates per Hour will be divided by two (2). Allowing the truck to have the age clause (outlined in B18.2) applied to it, plus the sander will have the age clause applied to it. That rate will then be entered for slotting.
- (a) Eg: price per hour thirty (\$30.00) dollars
 - 2010 sander $\$15.00 - (\$15.00 \times 15\% = \$2.25) = \12.75
 - 2010 truck $\$15.00 - (\$15.00 \times 15\% = \$2.25) = \underline{\$12.75}$
- \$25.50
- (b) Failure to supply registration may cause the unit not to be hired if registration is required.
- B10.10 Weekend & Statutory Holiday Premiums
- B10.10.1 An overtime premium of \$16.12/hour will be paid for each hour of equipment/truck time worked during the weekend period 19:00 Friday to 19:00 hours Sunday.
- B10.10.2 An overtime premium will also be paid for Work on a statutory holiday or Remembrance Day. In the event that one of these holidays falls on a Friday then the premium will be paid for all equipment/truck hours worked between 10:00 Thursday to 19:00 Sunday. Similarly, if one of these holidays falls on a Monday, then a premium will be paid for all equipment/truck hours worked between 19:00 Friday to 19:00 Monday.
- B10.10.3 Should a statutory holiday or Remembrance Day fall on a Tuesday, Wednesday or Thursday, an overtime premium will be paid for all hours worked from 19:00 hours the day prior to 19:00 hours on the day of the holiday.
- B10.10.4 Statutory holidays are New Year's Day, Louis Riel Day, Good Friday, Victoria Day, Canada Day, Labour Day, Thanksgiving Day and Christmas Day.
- B10.10.5 Any weekend or statutory holiday premium paid to the equipment/truck operator is the sole responsibility of the equipment/truck owner. Notwithstanding that the Contractor may be required by law to pay overtime to his employees if they have worked excessive hours.

B10.11 Equipment and trucks called out shall be paid a minimum of two (2) hours if work does not proceed and a minimum of four (4) hours if work does proceed. The hour rates quoted are from the time that the equipment reaches the Site until the specific Work is completed. Travel time to and from the Work is the responsibility of the Contractor and the City will not pay for same. IF there is any doubt the Contractor should contact the City's Equipment Coordinator at 204-986-6481.

B10.11.1 All callouts shall include Work assigned at one or more locations and includes Work assigned for different users.

B11. DISCLOSURE

B11.1 Various Persons provided information or services with respect to this Work. In the City's opinion, this relationship or association does not create a conflict of interest because of this full disclosure. Where applicable, additional material available as a result of contact with these Persons is listed below.

B11.2 The Persons are:

(a) N/A

B12. PROVISION FOR GUARANTEED EQUIPMENT

B12.1 The City is interested in entering into an agreement for the guaranteed provision of a limited number of loaders and graders for the 2021/2022 winter season. Bidders who may be interested in making such a commitment to the City must complete Form B: To apply your equipment for the Guaranteed List refer to Form B: and make a "X" next to the class code for your unit in the first column entitled "Guaranteed Equipment". If a unit is not indicated for the Guaranteed List on Form B: it will not be considered for the Guaranteed List.

B12.2 The City is prepared to enter to enter into agreements to ensure the availability of a minimum number of pieces if the following classifications:

(a) 25 x K6 Motor Graders

(b) 30 x J3 Loaders

(c) 15 x J5 Loaders

B12.2.1 All guaranteed equipment must be available for inspection and use on November 1, 2021. Notwithstanding the generality of C16, an act of God will not be considered a reason for guaranteed equipment not available for inspection on November 1, 2021.

B12.3 Bidders who have indicated an interest to provide guaranteed equipment for the K6 (Motor Grader) class will be required to have a snow wing available for each Motor Grader provided. The Snow Wing premium rate will be added to the Guaranteed rate for a minimum of thirty (30) hours for each of the five (5) months of the guarantee.

B12.4 Bids for the supply of guaranteed equipment will not be accepted if the correct Serial Number of the unit Bid is not provided.

B12.5 Lease agreements without the correct Serial Number of units Bid will not be accepted.

B12.6 Bidders who have indicated an interest to provide guaranteed equipment on Form B: will be contacted in order of equipment age to fulfill the City's required number of guaranteed equipment in each area.

B12.7 Current equipment will be given the highest slotting advantage. In the event that a Bidder does supply a non-current (future) model with Serial Number, it will be slotted along with the current year models and will be given no additional slotting advantage.

B12.8 Guaranteed equipment must be available for each shift (day and night) that the City works during a major plowing operation, or as called out by the Contract Administrator.

- B12.9 Guaranteed payments will be based on thirty (30) hours a month for each five (5) months during the winter season – November through March.
- B12.10 Guaranteed payments will be offset by hours worked but only within the month actually worked.
- B12.11 Equipment commitment is for snow clearing operations and callout will be made at the sole discretion of the Contract Administrator.
- B12.12 Every effort will be made to utilize guaranteed equipment in their preferred areas. However there may be isolated events where the guaranteed equipment will be expected to Work in other areas of the City.

B13. CONFLICT OF INTEREST AND GOOD FAITH

- B13.1 Further to C3.2, Bidders, by responding to this Tender, declare that no Conflict of Interest currently exists, or is reasonably expected to exist in the future.
- B13.2 Conflict of Interest means any situation or circumstance where a Bidder or employee of the Bidder proposed for the Work has:
- (a) other commitments;
 - (b) relationships;
 - (c) financial interests; or
 - (d) involvement in ongoing litigation;
- that could or would be seen to:
- (i) exercise an improper influence over the objective, unbiased and impartial exercise of the independent judgment of the City with respect to the evaluation of Bids or award of the Contract; or
 - (ii) compromise, impair or be incompatible with the effective performance of a Bidder's obligations under the Contract;
- (e) has contractual or other obligations to the City that could or would be seen to have been compromised or impaired as a result of its participation in the Tender process or the Work; or
- (f) has knowledge of confidential information (other than confidential information disclosed by the City in the normal course of the Tender process) of strategic and/or material relevance to the Tender process or to the Work that is not available to other bidders and that could or would be seen to give that Bidder an unfair competitive advantage.
- B13.3 In connection with its Bid, each entity identified in B13.2 shall:
- (a) avoid any perceived, potential or actual Conflict of Interest in relation to the procurement process and the Work;
 - (b) upon discovering any perceived, potential or actual Conflict of Interest at any time during the Tender process, promptly disclose a detailed description of the Conflict of Interest to the City in a written statement to the Contract Administrator; and
 - (c) provide the City with the proposed means to avoid or mitigate, to the greatest extent practicable, any perceived, potential or actual Conflict of Interest and shall submit any additional information to the City that the City considers necessary to properly assess the perceived, potential or actual Conflict of Interest.
- B13.4 Without limiting B13.3, the City may, in its sole discretion, waive any and all perceived, potential or actual Conflicts of Interest. The City's waiver may be based upon such terms and conditions as the City, in its sole discretion, requires to satisfy itself that the Conflict of Interest has been appropriately avoided or mitigated, including requiring the Bidder to put into place such policies, procedures, measures and other safeguards as may be required by and be acceptable to the City, in its sole discretion, to avoid or mitigate the impact of such Conflict of Interest.

- B13.5 Without limiting B13.3, and in addition to all contractual or other rights or rights at law or in equity or legislation that may be available to the City, the City may, in its sole discretion:
- (a) disqualify a Bidder that fails to disclose a perceived, potential or actual Conflict of Interest of the Bidder or any of its employees proposed for the Work;
 - (b) require the removal or replacement of any employees proposed for the Work that has a perceived, actual or potential Conflict of Interest that the City, in its sole discretion, determines cannot be avoided or mitigated;
 - (c) disqualify a Bidder or employees proposed for the Work that fails to comply with any requirements prescribed by the City pursuant to B13.4 to avoid or mitigate a Conflict of Interest; and
 - (d) disqualify a Bidder if the Bidder, or one of its employees proposed for the Work, has a perceived, potential or actual Conflict of Interest that, in the City's sole discretion, cannot be avoided or mitigated, or otherwise resolved.

B13.6 The final determination of whether a perceived, potential or actual Conflict of Interest exists shall be made by the City, in its sole discretion.

B14. QUALIFICATION

B14.1 The Bidder shall:

- (a) undertake to be in good standing under The Corporations Act (Manitoba), or properly registered under The Business Names Registration Act (Manitoba), or otherwise properly registered, licensed or permitted by law to carry on business in Manitoba, or if the Bidder does not carry on business in Manitoba, in the jurisdiction where the Bidder does carry on business; and
- (b) be financially capable of carrying out the terms of the Contract; and
- (c) have all the necessary experience, capital, organization, and equipment to perform the Work in strict accordance with the terms and provisions of the Contract.

B14.2 The Bidder and any proposed Subcontractor (for the portion of the Work proposed to be subcontracted to them) shall:

- (a) be responsible and not be suspended, debarred or in default of any obligations to the City. A list of suspended or debarred individuals and companies is available on the Information Connection page at The City of Winnipeg, Corporate Finance, Materials Management Division website at <https://www.winnipeg.ca/matmgt/Templates/files/debar.pdf>

B14.3 The Bidder and/or any proposed Subcontractor (for the portion of the Work proposed to be subcontracted to them) shall:

- (a) have successfully carried out work similar in nature, scope and value to the Work; and
- (b) be fully capable of performing the Work required to be in strict accordance with the terms and provisions of the Contract; and
- (c) have a written workplace safety and health program, if required, pursuant to The Workplace Safety and Health Act (Manitoba).

B14.4 The Bidder shall submit, within three (3) Business Days of a request by the Contract Administrator, proof satisfactory to the Contract Administrator of the qualifications of the Bidder and of any proposed Subcontractor.

B14.5 The Bidder shall provide, on the request of the Contract Administrator, full access to any of the Bidder's equipment and facilities to confirm, to the Contract Administrator's satisfaction, that the Bidder's equipment and facilities are adequate to perform the Work.

B15. OPENING OF BIDS AND RELEASE OF INFORMATION

- B15.1 Bids will not be opened publicly.
- B15.2 After evaluation, the name(s), of the successful Proponent(s) who will be on the callout list, their address(es) and hourly rates will be available on the **MERX website at www.merx.com**.
- B15.3 After award of Contract, the name(s) of the successful Bidder(s) and their Contract amount(s) will be available on the **MERX website at www.merx.com**.
- B15.4 The Bidder is advised that any information contained in any Bid may be released if required by The Freedom of Information and Protection of Privacy Act (Manitoba), by other authorities having jurisdiction, or by law or by City policy or procedures (which may include access by members of City Council).
- B15.4.1 To the extent permitted, the City shall treat as confidential information, those aspects of a Bid Submission identified by the Bidder as such in accordance with and by reference to Part 2, Section 17 or Section 18 or Section 26 of The Freedom of Information and Protection of Privacy Act (Manitoba), as amended.

B16. IRREVOCABLE BID

- B16.1 The Bid(s) submitted by the Bidder shall be irrevocable for the time period specified in **Paragraph 11 of Form A: Bid/Proposal**.
- B16.2 The acceptance by the City of any Bid shall not release the Bids of the next two lowest evaluated responsive Bidders and these Bidders shall be bound by their Bids on such Work until a Contract for the Work has been duly formed and the contract securities have been furnished as herein provided, but any Bid shall be deemed to have lapsed unless accepted within the time period specified in **Paragraph 11 of Form A: Bid/Proposal**.

B17. WITHDRAWAL OF BIDS

- B17.1 A Bidder may withdraw his/her Bid without penalty at any time prior to the Submission Deadline.

B18. EVALUATION OF BIDS

- B18.1 Award of the Contract shall be based on the following bid evaluation criteria:
- (a) compliance by the Bidder with the requirements of the Tender, or acceptable deviation therefrom (pass/fail);
 - (b) qualifications of the Bidder and the Subcontractors, if any, pursuant to B14(pass/fail);
 - (c) Call Out List for Semi-Trailer Dump Trucks will be determined using the actual floor length of the trailer. This length will then be divided in the rate per hour and that rate will be for slotting purposes only. The frame is not measured and the length it was purchased has no bearing. The measurement is from the front edge of the floor to the tailgate. See example E2.4 NOTE: NO registration or ownership papers no slotting.
 - (d) Call Out List for all other equipment will be determined as per B18.2.
- B18.1.1 If more than one (1) unit of a class is quoted by the Bidder, the Streets Maintenance Division will endeavour to assign all units in that class to the same Bidding area. However, if a Bidder quotes more than one (1) class of equipment, there is no guarantee expressed or implied that all equipment will be assigned to the same Bidding area. This does not include guaranteed equipment. Guaranteed equipment will be assigned where needed.

B18.2 For the Purposes of slotting only, the following formula will be used:

- (a) equipment originally manufactured after **2018** shall be given a **35%** price/hour advantage;
- (b) equipment originally manufactured after **2015** shall be given a **28%** price/hour advantage;
- (c) equipment originally manufactured after **2012** shall be given a **22%** price/hour advantage;
- (d) equipment originally manufactured after **2009** shall be given a **15%** price/hour advantage;
- (e) equipment originally manufactured in **2009** and prior years shall be given no price/hour advantage.

Example:

	Year	Bid	Slotting Price	Slotting Advantage
Grader built: a)	2019	\$40.00	\$26.00	35%
b)	2016	\$40.00	\$28.80	28%
c)	2013	\$40.00	\$31.20	22%
d)	2010	\$40.00	\$34.00	15%
f)	2009 or prior	\$40.00	\$40.00	0%

B19. AWARD OF CONTRACT

B19.1 This Tender is to establish pay rates and a hiring order for snow clearing equipment and/or semi-trailer dumps for the 2021-2022 Snow Season. Snow clearing activities for the Public Works Department conducted on City roads, lanes, sidewalks and other areas, as necessary, shall include, but not necessarily be limited to plowing, hauling and/or loading snow, widening roadways and/or sidewalks, scarifying ice, spreading sand/salt/aggregate and levelling and maintenance of snow dump sites (referred to herein as “the Work”).

B19.2 The City will have no obligation to award a Contract to a Bidder, even though one or all of the Bidders are determined to be qualified, and the Bids are determined to be responsive.

B19.2.1 Without limiting the generality of B19.1, the City will have no obligation to award a Contract where:

- (a) the prices exceed the available City funds for the Work;
- (b) the prices are materially in excess of the prices received for similar work in the past;
- (c) the prices are materially in excess of the City’s cost to perform the Work, or a significant portion thereof, with its own forces;
- (d) only one Bid is received; or
- (e) in the judgment of the Award Authority, the interests of the City would best be served by not awarding a Contract.

B19.3 This Tender shall not be interpreted by the Contractor(s) as an obligation on the part of the City to provide Work, or as the representation that Work is available. Work, if and when available, at the discretion of the Contract Administrator, shall be assigned in accordance with the terms and conditions of this Tender.

PART C - GENERAL CONDITIONS

C0. GENERAL CONDITIONS

- C0.1 The *General Conditions for Supply of Services* (Revision 2020-01-31) are applicable to the Work of the Contract.
- C0.1.1 The *General Conditions for Supply of Services* are available on the Information Connection page at The City of Winnipeg, Corporate Finance, Materials Management Division website at http://www.winnipeg.ca/matmgt/gen_cond.stm
- C0.2 A reference in the Tender to a section, clause or subclause with the prefix “**C**” designates a section, clause or subclause in the *General Conditions for Supply of Services*.

PART D - SUPPLEMENTAL CONDITIONS

GENERAL

D1. GENERAL CONDITIONS

D1.1 In addition to the *General Conditions for Supply of Services*, these Supplemental Conditions are applicable to the Work of the Contract.

D2. SCOPE OF WORK

D2.1 The Work to be done under the Contract shall consist of Provision of Hourly Rates for Hired Equipment and Dump Trucks 2021-2022 Snow Season.

D2.2 The City shall be the sole judge of what Work will be performed under this Contract.

D2.3 The City reserves the right to issue other Tenders for equipment/dump trucks.

D2.4 The City reserves the right to by-pass a lower Bid piece of equipment/dump truck, if it is deemed inadequate for that particular job.

D2.4.1 A map of the Bidding areas' boundaries for snow equipment only is attached to this Specification, for reference in Appendix A.

D2.4.2 Bid price (lowest area price in a class) is an indication of the area the Contractor prefers to Work in.

D3. DEFINITIONS

D3.1 When used in this Tender:

- (a) **"Business Day"** means any Calendar Day, other than a Saturday, Sunday, or a Statutory or Civic Holiday.
- (b) **"Submission Deadline"** and **"Time and Date Set for the Final Receipt of Bids"** means the time and date set out in the Bidding Procedures for final receipt of Bids.

D4. CONTRACT ADMINISTRATOR

D4.1 The Contract Administrator is:

Abe Wiebe
Field Support Services Supervisor
Telephone No. 204 470-7922
Email Address. abewiebe@winnipeg.ca

D4.2 At the information meeting, the Contract Administrator will identify additional personnel representing the Contract Administrator and their respective roles and responsibilities for the Work.

D5. CONTRACTOR'S SUPERVISOR

D5.1 Further to C6.22, the Contractor shall employ and keep on the Work, at all times during the performance of the Work, a competent supervisor and assistants, if necessary, acceptable to the Contract Administrator. The supervisor shall represent the Contractor on the Site. The supervisor shall not be replaced without the prior consent of the Contract Administrator unless the supervisor proves to be unsatisfactory to the Contractor and ceases to be in his/her employ.

D5.2 Before commencement of Work, the Contractor shall identify his/her designated supervisor and any additional personnel representing the Contractor and their respective roles and responsibilities for the Work.

D5.2.1 Further to C5.5 Contract Administrator may give instructions or orders to the Contractor's supervisor and such instructions or orders shall be deemed to have been given to the Contractor.

D6. NOTICES

D6.1 Except as provided for in C22.4, all notices, requests, nominations, proposals, consents, approvals, statements, authorizations, documents or other communications to the Contractor shall be sent to the address or facsimile number identified by the Contractor in Paragraph 2 of Form A: Bid/Proposal.

D6.2 All notices, requests, nominations, proposals, consents, approvals, statements, authorizations, documents or other communications to the City, except as expressly otherwise required in, D6.3 or elsewhere in the Contract, shall be sent to the attention of the Contract Administrator identified in D4.

D6.3 All notices, requests, nominations, proposals, consents, approvals, statements, authorizations, documents or other communications required to be submitted or returned to the City Solicitor shall be sent to the following facsimile number:

The City of Winnipeg
Legal Services Department
Attn: Director of Legal Services
Facsimile No.: 204 947-9155.

SUBMISSIONS

D7. AUTHORITY TO CARRY ON BUSINESS

D7.1 The Contractor shall be in good standing under The Corporations Act (Manitoba), or properly registered under The Business Names Registration Act (Manitoba), or otherwise properly registered, licensed or permitted by law to carry on business in Manitoba, or if the Contractor does not carry on business in Manitoba, in the jurisdiction where the Contractor does carry on business, throughout the term of the Contract, and shall provide the Contract Administrator with evidence thereof upon request.

D8. WORKERS COMPENSATION

D8.1 The Contractor shall be registered with the Workers Compensation Board of Manitoba, shall provide and maintain Workers Compensation coverage throughout the term of the Contract, and shall provide the Contract Administrator with evidence thereof upon request. Commencement of Work will not be allowed prior to the confirmation of coverage with the Workers Compensation Board.

D8.2 In the event of default of Workers Compensation coverage, the City of Winnipeg will withhold funds and Work until the Contractor has the appropriate coverage and evidence is provided to the Contract Administrator.

D9. INSURANCE

D9.1 The Contractor providing unlicensed equipment (Contractors Equipment) shall provide and maintain the following insurance coverage:

- (a) commercial general liability insurance in the amount of at least two million dollars (\$2,000,000.00) inclusive, with The City of Winnipeg added as an additional insured; such liability policy to also contain a cross-liability clause, contractual liability, unlicensed motor vehicle liability, non-owned automobile liability and products and completed operations cover, to remain in place at all times during the performance of the Work;
- (b) property insurance for your Contractors equipment;

- D9.2 The Contractor providing licensed equipment (insured through MPI or another Auto liability carrier) shall provide and maintain the following insurance coverage:
- (a) Automobile Liability Insurance covering all motor vehicles, owned and operated and used or to be used by the Contractor directly or indirectly in the performance of the Service. The Limit of Liability shall not be less than \$2,000,000 inclusive for loss or damage including personal injuries and death resulting from any one accident or occurrence;
 - (b) commercial general liability insurance in the amount of at least two million dollars (\$2,000,000.00) inclusive, with The City of Winnipeg added as an additional insured; such liability policy to also contain a cross-liability clause, contractual liability, non-owned automobile liability and products and completed operations cover, to remain in place at all times during the performance of the Work;
 - (c) Confirmation – either under the Automobile Liability policy OR the commercial general liability policy that coverage includes loading and unloading / hauling and dumping.
- D9.3 The Certificate must clearly state: “Operations include snow clearing on City right-of-way’s during winter months” (i.e. insurance to cover snow clearing and ice control of streets, roadways, sidewalks back lanes /alleys, etc.).
- D9.4 All policies shall be taken out with insurers licensed in the Province of Manitoba.
- D9.5 **Deductibles must be expressly stated on the certificate of insurance and must not exceed \$5,000.00. Any variation of the deductible are subject the Supervisor Insurance and/or Corporate Risk Manager approval.**
- D9.6 Commercial general liability deductible must be expressly stated on the certificate of insurance.
- D9.7 Deductibles shall be borne by the Contractor.
- D9.8 The Contractor shall file with the City certificates of insurance, confirming and expressly stating all requirements, in a form satisfactory to the City Solicitor; these certificates must be received by the City and approved, prior to commencement of any Work.
- D9.9 The Contractor shall not cancel, materially alter, or cause the policy to lapse without providing at least fifteen (15) Calendar Days prior written notice to the Contract Administrator.
- D9.10 The City shall have the right to alter limits and/or coverages as reasonably required from time to time during the continuance of this agreement.
- D9.11 The City will require proof of insurance before any piece of equipment can be utilized. Failure to provide the necessary documentation will result in the removal of that equipment until the necessary documentation has been provided.
- D9.12 If not engaged in snow clearing operations, the certificate must clearly state the Contractor’s specific operations.

D10. DAMAGE CLAIMS

- D10.1 The Contractor shall report to the City any event resulting in injury or damage immediately following the occurrence of such event, and the receipt of notice of an action, proceeding, claim or demand alleging or giving notice of injury immediately following receipt thereof, to the City of Winnipeg Claims Branch.
- D10.2 The City shall notify the Contractor of all claims of injury or damage alleged to have been caused by the Contractor or his equipment of which it receives notice.
- D10.3 **Reports or claims of injury or damage reported by the Contractor or of which the Contract Administrator or designate from the Risk Management Division has received notice will be dealt with as follows:**

D10.3.1 The Contract Administrator or designate will identify if the damage was caused by a negligent action on behalf of the Contractor. The Contract Administrator or designate shall then, notify the Contractor of the claim by email/Canada Post mail, and include all supporting documentation; the Contractor shall contact the claimant in writing by mail within 30 days of the receipt of the email/letter from the City, providing their position on liability, with a copy sent by email to the City of Winnipeg's Claims Branch at FINclaim@winnipeg.ca. If a Contractor fails to contact the claimant within 30 days outlining their position on liability, the City will take these acts of inaction into consideration and may suspend callout of equipment for 6 months or debar for 3 years.

D10.3.2 If it is determined by the Contract Administrator or designate that the damage identified is considered unforeseen damage, the City of Winnipeg will respond to the property owner with respect to liability in the matter.

D10.4 The Contractor shall provide to the City an active email address to receive claim notifications.

SCHEDULE OF WORK

D11. COMMENCEMENT

D11.1 The Contractor shall not commence any Work until he/she is in receipt of a notice of award from the City authorizing the commencement of the Work.

D11.2 The Contractor shall not commence any Work on the Site until:

- (a) the Contract Administrator has confirmed receipt and approval of:
 - (i) evidence of authority to carry on business specified in D7;
 - (ii) evidence of the workers compensation coverage specified in D8;
 - (iii) evidence of the insurance specified in D9;
- (b) the Contractor has attended a meeting with the Contract Administrator, or the Contract Administrator has waived the requirement for a meeting.

D11.3 The Contractor must provide the City with their G.S.T. registration number at least 24 hours prior to commencement of Work. If the G.S.T. registration number is not supplied within 24 hours of Work, then the Contractor will not receive G.S.T. payment for the first 24 hours after the number is received.

D12. DECLARATION BY CONTRACTOR

D12.1 The Contractor declares that he has submitted his Bid and entered into this Contract with the City in good faith and that to the best of his knowledge no member of Council, or any officer or employee of the City has any pecuniary interest, direct or indirect, in the said Contract, and further that the said Contractor shall forfeit all claims under this Contract for Work done beyond the actual proven expenses of the Contractor if any member of Council, or any officer or employee of the City is at any time interested therein is given or agreed to be given to him and as well shall refund to the City any monies paid to the Contractor by the City under this Contract beyond the actual expenses of the Contractor. The Contractor declares that he has not participated in any collusive scheme or combines in connection with his Bid or Contract.

D13. EQUIPMENT AND TRUCK RELIABILITY

D13.1 At the sole discretion of the Streets Maintenance Division, equipment or trucks which show a history of breakdowns and/or not reporting for Work or of being substituted for will be suspended and no further attempts will be made to hire the said piece of equipment or truck until it has been re-evaluated by the Streets Maintenance Division. The Contractor shall produce copies of Work orders indicating that the equipment or truck has been repaired or that other problems have been rectified. Also, all equipment/trucks must comply to the Specifications and safety requirements in this Tender or the unit will not be used.

D13.2 When a Contractor Bids more than one unit in a class and the unit price for this equipment is different, the unit with the lowest slotted price will be hired first. If the lower priced unit in a class is not available, the next higher priced unit will be used but only if it qualifies as a substitute in accordance with D23. In addition, the impacts of slotting and age advantage will be considered.

D14. COVID-19 SCHEDULE DELAYS

D14.1 The City acknowledges that the schedule for this Contract may be impacted by the COVID-19 pandemic. Commencement and progress of the Work shall be performed by the Contractor with due consideration to the health and safety of workers and the public, directives from health authorities and various levels of government and in close consultation with the Contract Administrator.

D14.2 If the Contractor is delayed in the performance of the Work by reason of the COVID-19 pandemic, the Work schedule may be adjusted by a period of time equal to the time lost due to such delay and costs related to such delay will be determined as identified herein.

D14.3 A minimum of seven (7) Calendar Days prior to the commencement of Work, the Contractor shall declare whether COVID-19 will affect the start date. The Contractor shall provide sufficient evidence that the delay is directly related to COVID-19, including but not limited to evidence related to availability of staff, availability of Material or work by others.

D14.4 For any delay related to COVID-19 and identified after Work has commenced, the Contractor shall within seven (7) Calendar Days of becoming aware of the anticipated delay declare the additional delay and shall provide sufficient evidence as indicated in D14.3. Failure to provide this notice will result in no additional time delays being considered by the City.

D14.5 Any time or cost implications as a result of COVID-19 and in accordance with the above, as confirmed by the Contract Administrator, shall be documented in accordance with C7.

D15. OPERATOR'S COMPETENCE AND PERFORMANCE

D15.1 The Contractor's operator shall maintain all equipment/trucks in good working order and shall perform all obligations expressed and implied in this Tender in good, safe and workmanlike manner. Where, in the opinion of the City supervisor or foreman, an operator fails to meet the obligations expressed or implied in this Tender, and without limiting the generality of the foregoing, the operator is:

- (a) unqualified, incompetent; or
- (b) operating in an unsafe manner; or
- (c) not performing a satisfactory amount of Work; or
- (d) engaged in activity outside the City's interests. (including side-jobs)

D15.2 The equipment/truck and operator may be dismissed immediately and shall not be re-engaged until such time as the inadequacies that resulted in the dismissal have been remedied to the sole satisfaction of the Contract Administrator.

D15.3 Individuals under the age of 18 years are not permitted by the City of Winnipeg to operate any equipment used in snow clearing and ice control activities.

D16. OPERATOR BEST PRACTICES GUIDELINES

D16.1 All operators of truck plows, graders, loaders and sidewalk clearing equipment are required to complete the City of Winnipeg Snow Clearing Best Practices Online Orientation, and have a certificate of completion in possession when reporting to Work for the City.

- D16.2 The City of Winnipeg Snow Clearing Best Practices Guidelines is an online orientation that has the objective to educate and increase operator knowledge on how to best perform street snow clearing Work on City right-of-way. The online orientation is a joint venture between the City of Winnipeg Streets Maintenance Division and the Heavy Equipment & Aggregate Trucker Association (HEAT).
- D16.3 In order to take the online orientation, registration spots must be purchased from HEAT in order to receive a unique login credential and to have access. The cost per registration spot is \$25.00 for member and \$40.00 for non-member.
- D16.4 The cost per registration spot shall be borne by the Bidder.
- D16.5 Access to the online orientation can be found at www.citysnowremoval.ca and questions regarding registering for access should be sent to memberservices@heatmb.ca or by phone at 204-809-0142.

D17. SUSPENSION AND REMOVAL FROM CALLOUT LISTS

- D17.1 A private operator caught working on private property during City of Winnipeg working hours will be automatically suspended, pending a hearing.
- D17.2 Suspension from the callout lists may be made by the Contract Administrator, at his sole discretion, for any failure on the part of the Contractor to meet any of the obligations in the Tender.
- D17.3 If the City of Winnipeg determines that one of your equipment operators is not competent, or the piece of equipment is not appropriate, the operator or piece of equipment immediately will result in the equipment being released and sent home for the remainder of the shift. A second occurrence will result in the equipment being released and sent home, and that piece of equipment will not be permitted to Work for the City of Winnipeg until the next snow event following the end of storm clearing. A third occurrence will result in the operator and equipment or Contractor/equipment provider being removed from the call-out list for the remainder of snow season.
- D17.4 A Contractor who makes a substitution for guaranteed equipment without approval of the Contract Administrator will be removed from the guaranteed list immediately for the remainder of the winter season.
- D17.5 Additional obligations shall include, but shall not be limited to:
- (a) failure to supply an Operator/Driver with the appropriate driver's license for said piece of equipment/truck;
 - (b) equipment/truck mechanical condition;
 - (c) operator's attitude, ability or actions;
 - (d) failure to report to an assigned Work site;
 - (e) failure to report to the Work site at the assigned time;
 - (f) working without being assigned by the Equipment Co-ordinator;
 - (g) failure to bring equipment in for inspection, when requested to do so;
 - (h) failure to properly complete Work tickets;
 - (i) low productivity (at the sole determination of the City foreman or Supervisor);
 - (j) failure to report to the City of Winnipeg Claims Branch as required in D10.1;
 - (k) failure to co-operate with the Claims Investigator as required in D10.2;
 - (l) failure to settle any claim as required in D10.3;

- D17.6 After suspension, the Contractor will be requested to explain the circumstances that caused the suspension. The Contract Administrator at his discretion, may request that (but not limited to):
- (a) the operator be evaluated by City staff;
 - (b) the equipment/truck be repaired and inspected after repair; and/or
 - (c) the equipment/truck and operator be monitored in the field.
- D17.7 Removal from the callout list may result and future Contracts may not be awarded based on one or more instances of unacceptable performance at the sole discretion of the Contract Administrator.
- D17.7.1 If the Contractor should abandon the Work or if he were adjudged to be bankrupt or make a general assignment for the benefit of his creditors or if a receiver or liquidator should be appointed in respect of his assets or if he fails to comply with an order of the Contract Administrator given pursuant to any of the provisions of the Tender or if he should fail to make prompt payment of wages, or accounts for the purchase or rental of material or plant or disregard by-laws and statutory regulations or if he commits any other breach of the provisions of this Tender, which in the opinion of the Contract Administrator indicates an unwillingness or inability upon the part of the Contractor to carry out the terms thereof, the Contract Administrator may notify the Contractor to discontinue all Work or any part thereof, under this Tender, by a written notice to be served upon the Contractor. Should such notice being given, the Contractor shall forthwith discontinue the Work or such part thereof as the Contract Administrator shall designate.

CONTROL OF WORK

D18. OWNERS OF EQUIPMENT/TRUCKS AND THEIR EMPLOYEES

- D18.1 The Contractor, owner, owner/operator and/or operator of the equipment supplied under this Tender shall be considered an independent Contractor who will Work under the direction of a City employee and it is acknowledged and agreed that such person shall be a servant of the owner of the equipment/trucks and shall not be considered an employee of the City of Winnipeg.

D19. SAFETY REQUIREMENTS

- D19.1 Without limiting the following, all trucks and equipment must meet, or exceed, any applicable requirements including, but not limited to: Federal Acts and Regulations, the Manitoba Highway Traffic Act, The Workplace Safety and Health Act and Regulations, applicable standards (CSA, ANSI, etc.), and any applicable By-Laws, Policies, Directives, or Procedures, etc. of the City of Winnipeg.
- D19.2 All equipment shall be equipped with lighting to meet or exceed the requirements of the Public Works Department Equipment Lighting Visibility Standard as per Appendix C and regulations passed there under. Dump trucks, dump trailers or trucks mounted with other apparatus are to be equipped with strobe or revolving beacon.
- D19.3 All equipment and trucks Bid in this Tender shall be equipped with an operating back-up alarm.
- D19.4 Contractors (and their employees) hired by the City shall familiarize themselves with and abide by any and all requirements with regard to personal protective equipment and all standards pertinent to the supply and safe operation of equipment, as required by any and all applicable Federal, Provincial and Civic By-Laws, Acts, orders and regulations in force at the time this Tender is accepted, or which may subsequently be enacted.

- D19.5 Without limiting the foregoing, all operators/drivers shall have and use appropriate personal protective equipment, including but not limited to protective headwear, footwear, safety vests and hearing protection, etc., and must also abide by requirements of applicable Federal Acts and Regulations, the Manitoba Highway Traffic Act, The Workplace Safety and Health Act and Regulations, any applicable standards (CSA, ANSI, etc.), and applicable By-Laws, Policies, Directives, or Procedures, etc. of the City of Winnipeg.
- D19.6 Each crawler tractor/dozer working at a snow dump shall be equipped with an R.O.P.S. cab or canopy.
- D19.7 All crawler tractors/dozers used at snow dumps must be equipped with at least one oscillating or strobe amber beacon.
- D19.8 All equipment/trucks must comply with their applicable Specifications and safety requirements. If the equipment/trucks are found not to be in compliance with these requirements, Work will be immediately stopped, and the equipment in question not used until such time that the equipment meets the applicable requirement(s). Repeated infractions may result in the equipment being withdrawn from the equipment list at the discretion of the Contract Administrator.
- D19.9 Any infraction or disregard of the safety rules will not be tolerated. The City has the right to investigate and remove operators who do not comply with the safety rules and regulations. Depending on the severity and frequency of the infraction(s), the Contract Administrator may remove the Contractor from the callout list on an interim basis or for the balance of the terms of the Tender and may recommend to the Chief Administrative Officer that the Contractor be debarred and suspended in accordance with the Materials Management Policy.

D20. EQUIPMENT IDENTIFICATION

- D20.1 All equipment and trucks hired by the City via this Tender must be clearly labelled indicating Contractor's name and unit number as indicated on the Tender Forms with Price Bid.
- D20.2 Letters and numbers used for identification purposes must be a minimum of 100 mm in height and positioned in such a manner as to be clearly visible when standing at either side of the machine. Units with no name will be sent home and a replacement will be called. The unit sent home (replaced) cannot come back until the following week. As bumping occurs at end of the week for next week's Work if any.
- D20.3 It is absolutely imperative that unit numbers of equipment and trucks, and the unit numbers indicated on Work tickets (outlined in Provision D22 below) exactly match those numbers listed on the bid submission in Appendix A of this Tender. Failure to do so will result in computer rejection of the timekeeping entry associated with a piece of equipment or truck number referenced in error, and an associated delay in payment.
- D20.4 The City may institute a bar code sticker identification system for some or all of the equipment supplied in this Tender.

D21. WINNIPEG CLIMATE ACTION PLAN AND ANNUAL FUEL REPORTING

- D21.1 The Contractor shall submit to the Contract Administrator for approval no later than three (3) months following the end of the Contract, a detailed report (for the reporting period January 1st and December 31st of each calendar year) that includes accurate quantities of each type of fuel consumed for motor vehicles and equipment used in performing the Work, including the following details:
- D21.2 Total fuel use (in litres) for each fuel type consumed, sorted by vehicle/equipment type (light duty passenger, light duty pick-up, heavy duty, off-road) and year (where applicable)
- D21.3 If fuel use (in litres) is not available – total vehicle kilometers travelled, sorted by vehicle/equipment type (light duty passenger, light duty pick-up, heavy duty, off-road) and year (where applicable).

- D21.4 If fuel use (in litres) and vehicle kilometers travelled are not available – total vehicle usage (in hours), sorted by vehicle/equipment type (light duty passenger, light duty pick-up, heavy duty, off-road) and year (where applicable).
- D21.5 Any other information requested by the Contract Administrator.
- D21.6 The City will use the reports to track and report on total greenhouse gas production from vehicle use in both City operations and City contracted services. This initiative aims to reduce air pollution and the production of greenhouse gas emissions while demonstrating the City's commitment to environmental sustainability in implementing the Winnipeg Climate Action Plan.

MEASUREMENT AND PAYMENT

D22. WORK TICKETS

- D22.1 The Contractor and/or the Contractor's employees operating hired equipment for the City will be provided Work tickets, supplied by the City at the commencement of each shift and shall complete these Work tickets, at the end of each Work shift or when Work is completed or otherwise terminated. Work tickets must be completed so as to indicate date, location of Work, Contractor's name, supplier number, license number if applicable, equipment unit number, plus City issued number, description of equipment, start and finish time using 24 hour clock, operating hours, operator's signature and operator's printed name. The Work tickets must be signed by the project foreman or designate and shall be distributed as indicated on the bottom left corner of the ticket.
- D22.2 Failure to properly complete the above-mentioned Work tickets will result in delay of payment for the Work detailed, until such time as the tickets is corrected and re-submitted.
- D22.3 Continued failure to properly complete Work tickets may result in the Contractor's equipment being moved to the bottom of applicable hiring list or suspension from that list.

D23. SUBSTITUTIONS, REPLACEMENT AND AVAILABILITY

- D23.1 In the event equipment/trucks as quoted are not available when called, due to breakdown or other circumstances resulting in short-term non-availability of the equipment, the City may allow substitution of such equipment providing:
- (a) the substitute equipment/trucks are, in the opinion of the Contract Administrator, at least equal in all respects to the equipment for which it is being substituted, and is owned by the Contractor; and
 - (b) the substitution will be allowed up to a maximum of one week. If, in a period of ninety (90) Working Days, the quoted piece of equipment is not available on two separate occasions, the unit may be deemed unreliable and may be removed from the callout list.
- D23.2 The total number of units (within a class) from a Contractor working for the City shall not, due to such substitutions, exceed the total number of units originally quoted by that Contractor.
- D23.3 If the Contractor sells or otherwise disposes of a piece of equipment/truck detailed on the callout list, he will be allowed to replace that piece of equipment providing the replacement, is in the opinion of the Contract Administrator, at least equal in all respects to the equipment it is replacing and provided the piece of equipment being replaced has worked under the terms of and as a result of the Tender, for a minimum of five (5) Working Days in the current snow removal season.
- D23.4 All substitutions must be approved by the Contract Administrator prior to such equipment commencing Work, see D17.4 for how this applies to guaranteed equipment.

- D23.5 All requests to allow replacement of quoted equipment which has been disposed of shall be submitted in writing to:
Contract Administrator
Streets Maintenance Division
104-1155 Pacific Avenue
Winnipeg, MB R3E 3P1
- D23.6 If a piece of equipment/truck on the hiring list is used to replace another piece of equipment which is also listed, but has been disposed of, the original position of the replacement piece of equipment/truck will be forfeited in making the replacement.
- D23.7 The forfeited position is subject to review, at the written request of the Contractor affected, by the Contract Administrator. The decision resulting from the review by the Contract Administrator shall be final.
- D23.8 If a substitute or replacement piece of equipment would, by virtue of its specifications, normally be listed in an equipment class larger than that in which the equipment it is replacing was listed, the substitute or replacement equipment shall be listed in and hired from the same class and position as the unit it is replacing, as though no substitution or replacement had occurred.
- D23.9 Similarly, should a piece of equipment of at least like-size, not negatively affected by the equipment age provision, be substituted for or replace a piece of equipment which is negatively affected by the age provision, the substitute or replacement shall be listed in the same position as that which it is replacing.
- D23.10 The Contract Administrator reserves the right, at any time, at his discretion, to ask for proof that a unit quoted is in fact owned or leased by the Contractor. This proof may be by means of physical inspection of the equipment or by submission of documentation as deemed appropriate by the City.
- D23.11 In the event such proof is not produced, the equipment in question may be removed from the callout list.
- D24. WITHDRAWAL OF EQUIPMENT/TRUCKS PRIOR TO LAYOFF**
- D24.1 Should a piece of equipment/truck be withdrawn from operation prior to layoff without permission of the City, no further attempt shall be made by the City to employ equipment from the Contractor involved until an explanation indicating a delay beyond the reasonable control of the Contractor has been provided in writing by the Contractor.
- D24.2 If the aforesaid written explanation indicates that the withdrawal is for a reason beyond the control of the Contractor, the City may, but shall not be obliged to, rehire the Contractor's equipment.
- D25. RE-ARRANGEMENT OF HIRED EQUIPMENT AND TRUCKS**
- D25.1 In the event that re-arrangement of hired equipment and trucks is required in order to maintain proper order in accordance with a particular call out list, such re-arrangements shall only be made for the first starting hour of the shift on the Monday (shift starting after 19:00 Sunday is the first shift for Monday) of each week except where, in the opinion of the Contract Administrator, such rearrangement would not be in the best interest of the City.
- D25.2 In the event that re-arrangement or bumping of hired snow trailer/s is required in order to maintain proper order in accordance with a particular call out list, such re-arrangements shall be made for the first starting hour of the shift on the Monday (shift starting after 19:00 Sunday is the first shift for Monday) of each week except where, in the opinion of the Contract Administrator, such re-arrangement would not be in the best interest of the City.

D25.3 Notwithstanding the above, in the event of any all-out plowing event on Priority 1, Priority 2 and/or Priority 3 streets, rearrangement would then occur on the first Monday shift following the completion of the original plow. Layoffs for the original plow will be administered on a last-in first-out basis.

D25.4 Equipment or dump trailers which show a history of not reporting for Work with two call-outs (two separate events), breakdowns and/or being substituted for, will be placed at the bottom of the callout list for the balance of the terms of this Tender as referred in Provision D23 for the Tender.

D26. CONTRACTOR'S OFFICE AND TELEPHONE NUMBERS

D26.1 Each Contractor shall provide and maintain a valid 24-hour call-out telephone number with a person answering. If the person answering cannot give a firm commitment, the City will consider that the equipment and/or dump trailers are not available and will go to the next on the list.

D27. SPECIALIZED EQUIPMENT, TRUCKS AND DUMP TRUCKS

D27.1 Equipment/Trucks/dump trucks of a specialized nature or possessing specialized attachments, within a class, may be hired before a unit within the same class with a lower quoted rate provided such use is deemed beneficial to a given project by the Contract Administrator.

D28. PAYMENT FOR USE OF MOTOR GRADERS AND LOADERS DURING MAJOR PLOWING OPERATIONS

D28.1 Payment for motor grader and loader equipment utilized during Major Plowing Operations will be based on a Fixed Hourly Rate as listed in Table 1 and 2 below.

D28.2 For the purposes of this quotation Major Plowing Operations shall include the following work activities that are undertaken on a city-wide basis:

- (a) truck plowing of Priority I and/or II streets; or
- (b) grader plowing on Priority I, II, or III streets or some combination thereof; or
- (c) lane plowing; or
- (d) other activities that the Contract Administrator warrants during storm situations.

D28.3 Equipment that is made available to the City in the initial stages of a Major Plowing Operation will be compensated at the Base Rate for the applicable age and class of equipment.

D28.4 Equipment that is made available to the City at a later date during the Major Plowing Operation will be compensated at the Supporting Rate for the applicable age and class of equipment.

D28.5 Fixed and Supporting Hourly Rates for motor graders and loaders during Major Plowing Operations have been established by the City for the 2020/2021 winter season as follows:

Table 1
Fixed Hourly Rates – Motor Graders
(Major Plowing Operations Only)

Equipment Age	Equipment Class	Base Rate	Supporting Rate
Current Equipment	K4	\$158.17	\$142.35
	K5	\$164.88	\$148.39
	K6	\$171.16	\$154.04
Non-Current Equipment	K4	\$146.93	\$132.23
	K5	\$151.59	\$136.43
	K6	\$155.82	\$140.24
Previous Equipment	K4	\$132.61	\$119.35
	K5	\$136.25	\$122.63
	K6	\$140.48	\$126.44

Table 2
Fixed Hourly Rates – Loaders
(Major Plowing Operations Only)

Equipment Age	Equipment Class	Base Rate	Supporting Rate
Current Equipment	J2	\$101.77	\$91.58
	J3	\$112.79	\$101.51
	J5	\$134.01	\$120.60
Non-Current Equipment	J2	\$96.28	\$86.60
	J3	\$107.21	\$96.50
	J5	\$128.52	\$116.70
Previous Equipment	J2	\$86.04	\$77.43
	J3	\$95.43	\$85.88
	J5	\$115.22	\$103.69

D28.6 Contractor's equipment not on the guaranteed list will be placed on a call out list that will be established through a lottery. This list is different from the traditional list and will only be utilized during the major plowing operations. The list will be rotated monthly to ensure everyone has a fair and equitable opportunity to provide the Work. Equipment/trucks that Work in said month will be rotated to the bottom of the list. Equipment/trucks that are called out for Work will be rotated to the bottom of the list.

D29. PAYMENT

D29.1 Where the specific use is authorized in advance by the City, premium payments for ice-blades, V-plows, & snow wings used for snow clearing and/or ice cutting shall be as follows. Plain blades shall be included in quoted hourly rate:

	<u>Item</u>	<u>R/CODE</u>	<u>Premium</u>	<u>Explanation</u>
	a) Blade Change*	5	\$140.00	When a foreman calls for a blade change between shifts
D29.1.1	*This premium will only be paid for blade change (from plain to ice or ice to plain) when plowing conditions change plus plowing is already in process and a streets foreman wants a blade change for the next shift. No premium will be paid for any blade changes if equipment is already laid off.			
D29.1.2	All graders are to come with plain blades for the first shift they are called out for, unless they are requested to come with ice blades.			
	b) Ice (Saw Tooth)*	6	\$15.64/hour	This premium will be paid for motor graders equipped with ice blades only if ice blade use is authorized.
	c) V-Plows*	7	\$13.62/hour	This premium will be paid for a motor grader equipped with a "V" plow only if V-plow use is authorized.
	d) Snow Wing*	8	\$21.26/hour	This premium will be paid for motor graders and truck plows equipped with wing only if wing use is authorized.
D29.2	When the use of a V-plow and/or snow wing is specifically requested by the User, premiums for the V-plow and/or the snow wing shall be paid for the entire shift. Requests for V-plows and/or snow wings will be made on a per-shift basis and are only valid for that shift. The use of V-plows and/or snow wings without any expressed request in advance by the City will result in the premium for the V-plows and/or snow wings being not applicable.			
D29.3	Use Rate Code 11 for -I4 and use Rate Code 13 for Class E1-E2 and I5-I9:			
	(a) low bed trailers will be paid on a per move basis:			
	(i) used for transporting equipment listed in Class Code I4 \$225.00 per move;			
	(ii) used for transporting equipment listed in Class Codes E1 and E2, and I5 to I9 inclusive: \$288.00 per move.			
	(b) Equipment being transported by low bed will not be paid for while in transit.			
	(c) Unless otherwise approved by the Contract Administrator or designate, the low bed shall not be paid for where a piece of equipment has to be transported from the job site prior to lay off or is not available to continue working, and is substituted by or replaced with another piece of equipment from the same Contractor.			
	(d) Likewise, for a low bed used to transport both the original piece of equipment working and the substitute or replacement piece of equipment to and from the Work site, payment shall be made for one return move only.			
	(e) Should a special permit be required above the annual overload permit, the City of Winnipeg will reimburse the cost to the Contractor upon delivery of receipt.			
D30.	RATE ADJUSTMENTS – FUEL COSTS			
D30.1	The Contract Administrator, at his discretion, may adjust upwards or downwards, the rates quoted for equipment and dump trailer included in this Contract, considering an increase or decrease in fuel prices exceeding three (3) percent, based on prices paid by the Streets Maintenance Division for clear diesel fuel between September 1, 2021 and December 16, 2021 . Any rate adjustment shall only reflect that portion of fuel price increases or decreases in excess of the three (3) percent outlined above. Any adjustment shall be effective January 2, 2022 and will not be retroactive.			

D30.2 The hourly rate adjustments shall be based on the average hourly fuel consumption, based upon manufacturers' published specifications, averaged per equipment or dump trailer class, as calculated by the Contract Administrator, whose decision shall be final and binding.

D31. BASIS FOR HIRING AND LAYOFF

D31.1 Trucks and equipment in each class excluding motor graders and loaders will be hired and laid off on the basis of the quoted hourly rate, i.e.: the equipment or truck with the lowest quoted hourly rate in each class will be hired first and laid off last, subject to the other provisions of this Specification.

D31.2 Motor graders and loaders in each class that are required for maintenance plowing operations will be hired and laid off on the basis of the quoted hourly rate, i.e.: the equipment or truck with the lowest quoted hourly rate in each class will be hired first and laid off last, subject to the other provisions of this Specification.

D31.3 After the guaranteed equipment list is established for each class the remaining equipment becomes non-guaranteed motor graders and loaders in each class. Some of the non-guaranteed equipment will be required for major plowing operations and will be hired and laid off on the basis of the lottery call out list that is established by the City through a fair and equitable equipment draw. This equipment will be hired on as required basis. Non-guaranteed equipment which worked in a said month will be rotated to the bottom of the list for the following month. Equipment/trucks that are called but are not available for Work will be rotated to the bottom of the call-out list.

D31.4 There may be major plowing events when the City will not be utilizing every piece of guaranteed equipment. On those occasions the guaranteed equipment will be hired and laid off in each area on a rotational basis as established by the City in a fair and equitable manner.

D31.5 Orders pertaining to the hiring and laying off of trucks and equipment issued by the Streets Maintenance Division shall supersede any orders which may have been issued by a supervisor, foreman or other official of a User group.

D32. CLAIMS

D32.1 In the event that the City errs in the slotting and/or the calling out of equipment and/or dump trailers the Contractor shall have no claim against the City.

D32.2 The City of Winnipeg as the "Owner" of the Work, has the right to determine which piece of equipment and/or dump trailer is most appropriate for any given Work.

D32.3 When snow sides are in place and trailer is being used for snow removal, the City of Winnipeg may not repair, nor pay for any damage done to tarps or apparatus used to move tarps.

D33. PAYMENT SCHEDULE

D33.1 Payment for hired hourly equipment and/or dump trailers shall be processed through the City of Winnipeg PeopleSoft Accounts Payable system. Payment shall be made bi-weekly subject to, but not limited to, proper documentation of Work tickets by the Contractor, the callout system being used and the correct equipment and/or dump trailers responding to callout. All payments are subject to the approval of the Contract Administrator.

D34. DUPLICATION OF MAKE, MODEL AND SERIAL NUMBER

D34.1 If two or more Contractors bid the identical machine, the Contract Administrator shall determine which Bid, if any, he shall accept. If one of the Bids is accepted for that equipment, all other Bids shall be rejected.

D34.2 If a Contractor uses a machine that was not Bid by the Contractor, the Contract Administrator shall take whatever considered appropriate action, including but not limited to, suspending all equipment quoted by the Contractor.

D35. EQUIPMENT CO-ORDINATOR

D35.1 The Equipment Coordinator for the Streets Maintenance Division is responsible for controlling and administering the day-to-day operation of the system for hiring snow equipment and trucks. The Equipment Co-ordinator performs the following major functions:

- (a) hiring and assignment of all snow equipment and trucks;
- (b) re-assignment of equipment/trucks;
- (c) maintenance of callout lists;
- (d) maintenance of records with respect to hired equipment; and
- (e) scrutiny of equipment and concerns.

D36. RESPECTFUL WORKPLACE ADMINISTRATIVE DIRECTIVE

D36.1 The City is committed to implementing and enforcing the Respectful Workplace Administrative Directive, which was approved by the Chief Administrative Officer in February 2002. The City recognizes its responsibility to build and maintain a respectful workplace where all employees enjoy an environment free of behaviours such as unlawful discrimination, harassment, disruptive workplace conflict, disrespectful behaviour and violence in the workplace. Harassment based on race, national or ethnic origin, colour, religion, age, sex, martial status, physical or mental disability, and/or sexual orientation is prohibited.

D36.2 The City recognizes that disruptive workplace conflicts and disrespectful behaviour can jeopardize an individual's dignity and well-being and/or undermine Work relationships and productivity. The City commits to providing a workplace based upon the principle of fair and respectful treatment in order to minimize these conflicts.

D36.3 In pursuance with the principles of the Directive, the Contractor shall fully comply with the Respective Workplace Administrative Directive and ensure that all persons he employs or retains to perform Work pursuant to the terms of this Tender comply with the Directive and behaves respectfully to both members of the public and to employees of the City, failing which the City has the right to investigate and instruct the Contractor to replace any person not behaving respectfully, upon written notice to the Contractor, and the Contractor shall comply with the instruction. The Contractor shall not re-employ or re-retain any person that the City has instructed him to replace for the purpose of performing any other or further Work on this Tender.

D36.4 Should a subsequent situation of disrespectful behaviour occur, the Contract Administrator may remove the Contractor from the callout list on an interim basis or for the balance of the term of the Contract and may recommend to the Chief Administrative Officer that the Contractor be debarred and suspended in accordance with the Materials Management Policy.

D36.5 As a guideline for situations where a Contractor may be approached by the media for an interview, Contractors are recommended to ask the media to contact City Corporate Communications at 204-986-6000 to coordinate their media request.

D37. DRIVER'S LICENSE FOR HIRED HOURLY TRUCKS AND EQUIPMENT

D37.1 The City requires that all Owners and Contractors ensure all drivers and operators have the appropriate driver's license for all hired hourly trucks and equipment supplied to the City.

D38. SUPPLYING CELL PHONE NUMBERS

D38.1 The City requires all hired equipment operators to have a cell phone and it is mandatory for the operators to provide the cell phone number to the area foreman.

PART E - SPECIFICATIONS

GENERAL

E1. APPLICABLE SPECIFICATIONS AND DRAWINGS

E1.1 These Specifications shall apply to the Work. All semi dump trucks, sanders, truck plows must use license plate number as unit number.

E2. SEMI-TRAILER TRUCKS

E2.1 Note: The City plans to only hire trucks with snow sides for its hauling operations. If, in the event of an emergency, the City extends the Work to include trucks without snow sides, those trucks will be hired from the summer construction Tender.

E2.2 Class A7B – Semi-trailer for hauling snow with snow sides.

E2.3 Call Out List for Semi Dump Trucks will be determined. Using the actual floor length of the trailer. This length will then be divided in the rate per hour and that rate will be for slotting purpose only. The frame is not measured and the length it was bought as has no bearing. The measurement is from the front edge of the floor to the tailgate. See example. NOTE: NO registration or ownership papers no slotting.

E2.4 Semi-trailer snow sides shall be installed on drivers' side. Snow sides should be a minimum of 7 ft. in total height from floor of dump trailer, driver's side (See A in diagram below). Front edge of snow side must start from front where floor starts to taper upwards (if no tapered front, snow side to start at front edge of box.) and ends at tailgate (See B in diagram below). There must be a snow side across the total front of the trailer equivalent in height to side boards. The snow sides must be of sufficient strength to prevent the snow sides from breaking from the force of the snow blown against the snow sides or objects being propelled through the blower chute (minimum $\frac{3}{4}$ " plywood, no particle board or OSB will be allowed).

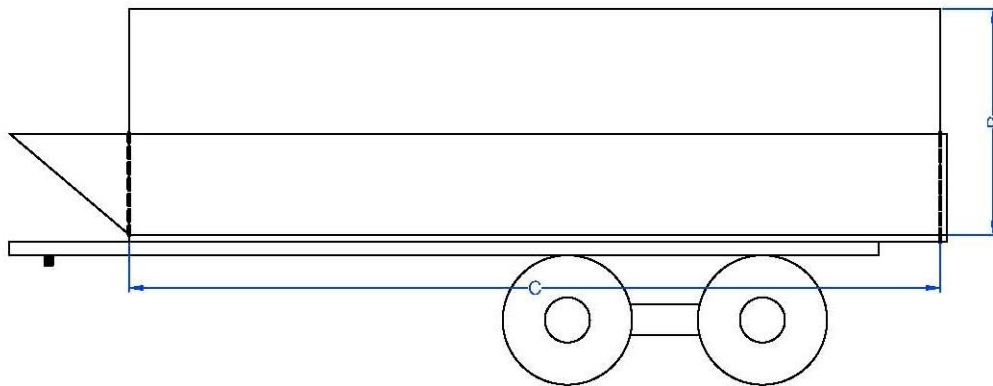

E2.5 Failure to comply to above will result in trailer being sent home until it meets the City criteria.

E2.6 The City of Winnipeg will not repair, nor pay for any damage done to tarps or apparatus used to move tarps.

E3. HYDRAULIC EXCAVATORS

E3.1 As described below:

- (a) Buckets shall be OEM spec's for hydraulic excavators.
- (b) The following buckets may be required on class D1, D2:

- (i) Regular: OEM Ditching Bucket – minimum 60" wide (5')
- (ii) Extra Wide: OEM Ditching Bucket Altered – minimum 84" wide (7') minimum 27" opening
- (c) D1 Rubber-Tired (Truck-Type) Carrier-Mounted
Minimum reach 17 ft.
Shall be equipped with remote travel control
Bucket Sizes:
- (d) D1 Regular ditching bucket - minimum 60" wide (5')
- (e) D1A Extra wide ditching bucket - minimum 84" wide (7') minimum 27" opening
- (f) D2 Rubber-Tired Single Engine - 4 Wheel-Drive
(Drott 40 Cruz-Air Type)
Minimum reach 17 ft
Bucket Sizes:
- (g) D2 Regular ditching bucket - minimum 60" wide (5')
- (h) D2A Extra wide ditching bucket - minimum 84" wide (7') minimum 27" opening
- (i) D2B Special Loading Bucket: for High Snow Piles
Height – OEM Ditching Bucket – minimum 27" opening
Width – OEM Ditching Bucket/ Altered – mini. 60" wide to maximum 84"
Depth – minimum 72"
Sides along extension – minimum 20" height to maximum 28"

E4. CRAWLER TRACTOR/DOZER

E4.1 All Crawler Tractor/Dozers shall be equipped with R.O.P.S. cab or canopy, back up alarm, fire extinguisher, as well as an amber oscillating strobe beacon.

E4.2 Crawler Tractor/Dozers as noted in the class codes below shall meet the following minimum specifications. No attachments on machines.

- (a) I7W (Winter Snow Push)
 - (i) operating weight 58,000 lbs. (26,308 kg);
 - (ii) net horsepower 210;
 - (iii) center blade height of 48" and a minimum blade surface area of 7,000 square inches;
 - (iv) end wings on blade with no less than 10" depth; and
 - (v) track width of 28" with grousers a minimum of 2.5".
- (b) I8W (Winter Snow Push)
 - (i) operating weight 80,000 lbs. (36,287 kg);
 - (ii) net horsepower 275;
 - (iii) center blade height of 60" and a minimum blade surface area of 9,500 square inches;
 - (iv) end wings on blade with no less than 10" depth; and
 - (v) track width of 28" with grousers a minimum of 3.0".

E4.3 As noted by the class code below: All dozers must have a track pad, a minimum of 26" and shall be equipped with R.O.P.S. cab or canopy, back up alarm, fire extinguisher as well as an amber oscillating strobe beacon. No attachment on machines:

- (a) I5 net minimum 145 hp;
- (b) I6 net minimum 175 hp;
- (c) I7 net minimum 210 hp;
- (d) I8 net minimum 275 hp.

E5. RUBBER TRACKED CRAWLER TRACTOR

E5.1 As noted by the class code below:

- (a) All units in RTC1, RTC2 and RTC3 classes to be equipped with a fourteen (14) foot-6way push blade with end wing attachments.
- (b) RTC1
 - (i) Gross Horsepower 250 – 325
 - (ii) Weight 33,000 lbs (14,968 kg) – 40,000 lbs (18,143 kg)
 - (iii) Wheelbase 100" (254 cm) – 115" (292 cm)
- (c) RTC2
 - (i) Gross Horsepower 325 – 500
 - (ii) Weight 40,000 lbs (18,143 kg) – 50,000 lbs (22,679 kg)
 - (iii) Wheelbase 115" (292 cm) – 125" (317 cm)
- (d) RTC3
 - (i) Gross Horsepower 500 – 650
 - (ii) Weight 40,000 lbs (18,143 kg) – 50,000 lbs (22,679 kg)
 - (iii) Wheelbase 115" (292 cm) – 125" (317 cm)

E6. RUBBER-TIRED FRONT END LOADER

E6.1 As noted by the class code below:

- (a) J2 Rubber-Tired - 4 Wheel Drive Loader
 - (i) SAE Net Horsepower Minimum 75 H.P.
 - (ii) Operating Weight 15,000 lbs. - 21,000 lbs.
 - (iii) Bucket Size 1.5 – 2.25 yd³.
- (b) J3 Rubber-Tired - 4 Wheel Drive Loader
 - (i) SAE Net Horsepower Minimum 100 H.P.
 - (ii) Operating Weight 21,000 lbs. to 30,500 lbs.
(9525.4 kg – 13834 kg)
 - (iii) Bucket Size 2.25 - 3 y d³.
- (c) J5 Rubber-Tired - 4 Wheel Drive Loader
 - (i) SAE Net Horsepower Minimum 150 H.P.
 - (ii) Operating Weight 30,500 lbs. – 42,500 lbs.
(13834 kg – 19277 kg)
 - (iii) Minimum Bucket Width 8' 9" (2.7 m)
- (d) J6 Rubber-Tired - 4 Wheel Drive Loader
 - (i) SAE Net Horsepower Minimum 200 H.P.
 - (ii) Operating Weight 42,500 lbs. - 45,000 lbs.
(19277 kg – 20412 kg)
 - (iii) Bucket Size 4.25 yd³ minimum
- (e) J7 Rubber-Tired - 4 Wheel Drive Loader
 - (i) SAE Net Horsepower Minimum 250 H.P.
 - (ii) Operating Weight 45,000 lbs. – 52,500 lbs
(20412 kg – 23813 kg)
 - (iii) Bucket Size 5 yd³ minimum

- (f) J8 Rubber-Tired – 4 Wheel Drive Loader
 - (i) SAE Net Horsepower Minimum 325 H.P.
 - (ii) Operating Weight 52,500 lbs & over
(23,813 kg & over)
 - (iii) Bucket Size 6 yd³ & over

E7. RUBBER-TIRED SKID STEERS AND TRACKLESS TRACTORS

E7.1 As noted by the class code below:

- (a) All units in J10 to J16 series to have heated cabs. All units shall have truck and trailer to move them to be included in hourly price quoted. No road travelling except for short distances. All units cannot be wider than the bucket or blade plowing width.
- (b) J10 Rubber-Tired Skid Steer Loader (Bridge Units)
 - (i) Bucket Minimum 34" – Maximum 47"
 - (ii) Minimum 15 HP to maximum 42 HP
 - (iii) Minimum weight 1900 lbs. (864 kgs)
- (c) J11 Rubber-Tired Skid Steer Loader
 - (i) Minimum net horsepower is 50 hp
 - (ii) Bucket width is minimum 60" (1.52 m), and maximum 68" (1.73 m).
 - (iii) Tires must not exceed width of the bucket.
- (d) J14 Trackless Tractors for Sidewalk Snow Clearing
 - (i) Snow blade - maximum 60"
 - (ii) Two-way blade controlled inside cab
 - (iii) Minimum 30" High.
- (e) J15 Rubber Tired Trackless Tractors With Angle Broom
 - (i) Minimum horsepower 70 HP
 - (ii) Minimum broom width 60 inches
 - (iii) Broom must be capable of angling both left and right
- (f) J16 Rubber Tired Trackless Tractor with Tow Behind Sidewalk Sander. Note: Will be Required to Plow and Sand Simultaneously.
 - (a) Trackless Tractor Specifications:
 - (i) Minimum net horsepower 70HP
 - (ii) Maximum width over tires 60"
 - (iii) Snow blade width 60"
 - (iv) Hitch, lighting and trailer brake hook ups
 - (v) 360° visibility oscillating amber beacon
 - (b) Tow Behind Sidewalk Sander Specifications:
 - (i) Minimum 2.0 CU YD. sand capacity
 - (ii) Maximum width 60"
 - (iii) Hydraulically driven conveyor and spinner with separate flow controller on each
 - (iv) 360° visibility oscillating amber beacon and slow-moving sign
 - (v) Outfitted with brakes and tractor operated trailer lights
- (g) J17 Tracked Tractors for Sidewalk Snow Clearing
 - (i) Snow blade – maximum 60"
 - (ii) Two-way blade controlled inside cab
 - (iii) Minimum 30" High
 - (iv) Minimum 100 HP

(v) Bombardier type

(h) J18 Rubber-Tired Skid Steer with Snow Blade

(i) Snow blade – maximum 66" width

(ii) Snow blade – minimum 30" height

(iii) Minimum 65 HP

(iv) 2-way blade

E8. MOTOR GRADER

E8.1 As noted by the class code below:

- (a) K3 125 to 139 flywheel horsepower
- (b) K4 140 to 159 flywheel horsepower
- (c) K5 160 to 170 flywheel horsepower
- (d) K6 180 and over flywheel horsepower

E9. TRUCK-MOUNTED SNOW PLOW

E9.1 As noted by the class code below:

- (a) (G.V.W. rated as stamped on plate on door jam, by vehicle manufacturer).
- (b) P1 Single Axle (27,000 lbs. {12 240 kg} G.V.W.) with a reversible plow, capable of tripping, minimum 8' (2.4 m) plow-clearing width. Wheel base should be based on standard measurement of 4.39m (14'5") from centre point front axle to centre point of rear axle \pm 0.127m (5").
- (c) P2 Tandem Axle (43,000 lbs. {19 500 kg} minimum G.V.W.) with reversible plow, capable of tripping, minimum 8' (2.4 m) plow-clearing width. Tandem axles may only be used in the event of a major storm.

E10. TRUCK-MOUNTED STREET SANDER – (MINIMUM 6 CU.YD/4.6 CU.M)

E10.1 As noted by the class code below:

E10.1.1 Sander Classes

- (a) S2 - Single Axle with no computerized spreader control;
- (b) S2C - Single Axle with computerized spreader control;
- (c) S3 - Tandem Axle with no computerized spreader control; and
- (d) S3C - Tandem Axle with computerized spreader control.

E11. TRUCK-MOUNTED STREET SANDER WITH COMPUTERIZED SPREADER CONTROLS

E11.1 Preference will be given to computerized sanders.

- (a) All hired sanders shall be equipped with a computer controlled sand spreader control system with closed loop and internal recording or equivalent.
- (b) All sanders must first pass an inspection by the City of Winnipeg Equipment inspector on the accuracy and ability to accept and maintain information supplied by the City before the sander will be slotted as computer controlled.

E11.2 All computerized sanders will be tested and calibrated to City of Winnipeg specifications for accuracy.

- (a) The first test is free. If additional tests are required the cost of the inspection will be paid by the Contractor.

- (b) All computers shall be accessible, adjustable, and able to accept and maintain the information supplied by the City of Winnipeg for sanding and salting of streets. Should a computer not readily accept the information supplied by the City on its first attempt, any further costs to adjust the computer will be borne by the Contractor.
- (c) It will not be considered to fall into the S2C and S3C class of computerized sanders until a computerized sander is fully operational.

E11.3 Requirement for Gate Sensor will not be applicable for this winter season.

E12. SNOW BLOWERS

E12.1 All Snow Blower units must be two stage.

E12.2 V1 Sidewalk Snow Blowers Mounted on Skid Steer Loaders for bridges.

- (a) Minimum 34", Maximum 48" cutting height approx. 30", minimum 270-degree rotation on discharge chute, full remote control from inside cab for chute while blowing snow.
- (b) All controls to be mounted inside cab. All cabs shall be enclosed and heated.

E12.3 V2 Sidewalk Snow Blowers Mounted on Skid Steer Loaders, equipped with High Flow Pumps with a minimum of 26 GPM along with a High Flow sidewalk snow blower.

- (a) Maximum 68" Cutting Width, Cutting Height approximately 30", minimum 270-degree rotation on discharge chute, full remote control from inside cab of chute while blowing snow.

E12.4 V4 Sidewalk Snow Blowers Mounted on Trackless Tractors

- (a) Maximum 60" cutting width. Cutting height approx. 30", minimum 270-degree rotation on discharge chute, full remote control from inside cab for chute while blowing snow.

E12.5 V6 Loader-Mounted Snow Blower

- (a) Heavy-duty industrial-type, 8' blower clearing width, minimum 180 HP.
- (b) Shall be able to blow (load) snow over a minimum of 8' sides.

E12.6 V7 Truck-Mounted Snow Blower

- (a) 8' blower clearing width.
- (b) Shall be able to blow (load) snow over a minimum of 8' sides

E13. TRUCK OR TRAILER MOUNTED DE-ICER/FLUSHER

E13.1 As noted by the class code below:

- (a) All units in the DF1 and DF2 classes to be equipped with computerized controls capable of spraying liquid over one to three (1-3) lanes simultaneously at the rate of 120L/LKm while travelling at a minimum of 60km/hr.
- (b) All units must be capable of recording and storing amounts of liquid delivered as well as lane kilometres covered.
- (c) All units in these classes must first pass an inspection by the City of Winnipeg Equipment Inspector on the accuracy and ability to accept and maintain information/rates supplied by the City before they will be slotted in these classes. Lighting will also be inspected.

E13.2 DF1 Single Axle Truck/Trailer Sprayer

- (a) 1,500 gallons (6,800 Litres) capacity.

E13.3 DF2 Tandem Axle Truck/Trailer Sprayer

- (a) 3,000 gallons (13,600 Litres) capacity.

APPENDICES

APPENDIX A – STREETS MAINTENANCE DIVISION

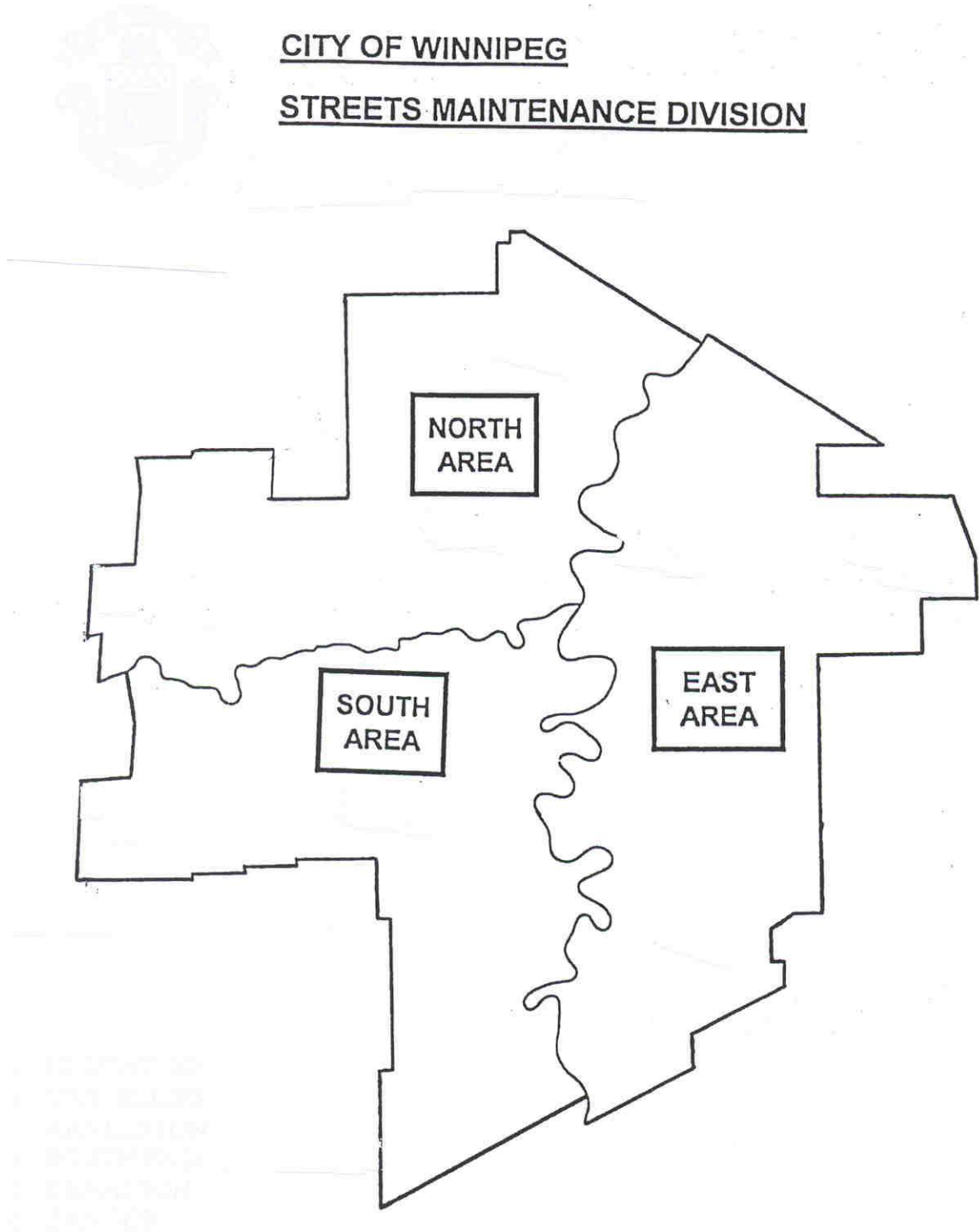

APPENDIX B – WORK TICKET SAMPLE

CW 318:2000 03

**CITY OF WINNIPEG
PUBLIC WORKS**

IF SHIFT
WORKED IS
NIGHT SHIFT
1. ACTUAL
DATES
SHOULD BE
SHOWN AS
INDICATED

EQUIPMENT
UNIT NUMBER
MODEL & TYPE
LIST ALL
ATTACHMENTS
E.G. WING & HRS.
WORKED

DATE MAY 21-22 / 2002	WORK ORDER NO. / ACCOUNT NO. / TASK NO.
--------------------------	---

TO BE COMPLETED
BY CITY OF WINNIPEG
PERSONNEL

LOCATION OF WORK: PORTAGE AND MAIN

EQUIPMENT UNIT NO.	DESCRIPTION	CITY UNIT NO.	USE 24 HOUR CLOCK		OPERATING TIME
			START	FINISH	
123	140G PATROL	1	22:00	07:00	9HRS.
			↑	↑	

START & FINISH
TIMES MUST BE
SHOWN USING
24 HOUR CLOCK

OWNER OF EQUIPMENT: FAMOUS EQUIPMENT RENTALS - 12345
(PLEASE PRINT)

COMPANY NAME
&
SUPPLIER NUMBER

OPERATORS NAME (PLEASE PRINT) _____ OPERATORS SIGNATURE _____

IF OPERATOR'S SIGNATURE
IS ILLEGIBLE, NAME MUST
BE PRINTED WHERE
PROVIDED OR BELOW
SIGNATURE

COMMENTS: (LAY OFF, BREAKDOWN, TRANSFERRED, DISMISSED, ETC.)
(ATTACHMENTS USED E.G. BLADES, RIPPER, ETC.)

NO LUNCH BREAK

LAI D OFF

WORK
TICKET
NUMBER

→ 134651

FOREMAN'S NAME
MUST BE LEGIBLE

DISTRIBUTION
WHITE - 1220 PACIFIC AVENUE
YELLOW - FOREMAN
PINK - RETAINED BY OPERATOR

FOREMAN'S SIGNATURE _____

CHECK ONE				
N	E	S	HYDRO	WW
PARKS	CENTRAL SERVICE		P.M.D.	

TO BE COMPLETED BY
CITY OF WINNIPEG
PERSONNEL

APPENDIX C – EQUIPMENT LIGHTING AND VISIBILITY REQUIREMENT



City of Winnipeg, Public Works Department
Human Resource Division - Safety Branch

Equipment Lighting and Visibility Requirements

Purpose

- To help ensure that adequate warning of work vehicles and equipment is provided to motorists, pedestrians and workers, in and adjacent to construction and maintenance work zones.
- To ensure high visibility lighting is adequate and consistent for all vehicles engaged in work activities for the City of Winnipeg's Public Works Department.

Scope

All vehicles and powered mobile equipment must be equipped with a consistent level of High Visibility Lighting(HVL) to ensure they are visible to motorists, pedestrians and workers. The risk level of equipment/vehicles determines the level of equipment lighting/visibility required. These risk levels are based upon work location and type, travel and working speeds, environmental conditions and applicable regulatory requirements, including but not limited to, the Highway Traffic Act.

This document is designed to assist with the purchase and placement of High Visibility Lighting and establishes the minimum specifications of High Visibility Lighting necessary to operate vehicles/equipment for or with the City of Winnipeg's Public Works Department, with the intent that all applicable Regulations are met or exceeded.

Hazard Categories and explanations for the different classes of equipment are included in the following pages, along with some practical examples. There are many different pieces of equipment that are not listed due to the variety of equipment involved, however, reference to general equipment types/classes are included to assist in ensuring that the equipment engaged is highly visible and meets the minimum requirements described in this document. Four Hazard categories are described in this document, with Level 1 having the highest risk to Level 4 having the lowest risk.

High Visibility Lighting is critical for the visibility of the equipment on the road and in work areas. With recent technological advances, the preferred High Visibility Lighting(HVL) for today's vehicles is becoming LED lighting, however other types will also meet these minimum HVL requirements. These LED lights can be extremely bright with a typically lower current draw on the vehicles electrical system, and can be more dependable and durable.

Be reminded that this document identifies minimum High Visibility Lighting(HVL) requirements, and vehicles/equipment can be equipped with additional High Visibility Lighting if a user wishes, providing the additional level of lighting does not create a hazard to motorists, pedestrians and workers, in and adjacent to construction and maintenance work zones.

With the exception of mobile machinery, valid permits for displaying beacons may be required to be in the vehicle at all times (see Appendices for additional information)..

All City of Winnipeg or contractor supplied equipment and vehicles must meet the minimum High Visibility Lighting requirements identified.



City of Winnipeg, Public Works Department
Human Resource Division - Safety Branch

Hazard Categories

Minimum visibility requirements and risk levels are as follows:

Level 1 – Highest Risk

- Equipment that falls under Level 1 includes, but is not limited to, units that operate against the flow of traffic, or which work on the roadway centerline such as:
 - Pavement Marking Truck
 - Water Truck (Figure 1.0)
 - Road Patcher
- Equipment Visibility **Must** include the following:
 - 360° visibility amber beacon/strobe light or equivalent
 - Approved flashing or sequential arrow traffic control device(Figure 1.2)
 - 4-way hazard lights
 - Retro-reflective striping

Figure 1.0



Figure 1.1



Figure 1.0 and 1.1: Tanker equipped with 4 beacons, retro-reflective striping and combined directional lighting/caution signage.

Figure 1.2



Figure 1.3



Figure 1.2 and 1.3: Roadpatcher with directional lighting and informational sign (note front and rear mounted beacon lights)



City of Winnipeg, Public Works Department
Human Resource Division - Safety Branch

Hazard Categories (continued)

Level 2

- Equipment that falls under Level 2 includes, but is not limited to, equipment that may work during periods of low visibility such as:
 - Sander
 - Truck Plow (greater than 1 ton)
 - Motor Grader
 - Tow Truck
- Equipment Visibility **Must** include:
 - 360° visibility amber beacon/strobe light or equivalent
 - 4-way hazard lights
 - Two strobe lights for the rear-facing warning lights
 - Retroreflective striping
- Additional lighting/signing is required on units being used for specific tasks, such as pilot vehicles, and shadow/buffer vehicles, etc (Appendix I). All equipment/vehicles used for snowplowing operations will be equipped with two strobe lights for the rear-facing warning lights for increased visibility(Appendix III)

Figure 2.0



NOTE - Blue beacons or strobes can **only** be used during Winter snow removal operations and must be removed or de-energized when the vehicle is not being used in snow removal operations (Figure 2.1 and 2.2)

NOTE - Vehicles typically traveling at a speed less than 40 kilometers per hour **must** be equipped with a slow moving vehicle sign indicating that it is a slow moving vehicle in compliance with the Highway Traffic Act. (See Appendix I)

Figure 2.0: Articulating Loader with roof mounted dual function, amber/blue LED beacon.

Figure 2.1



Figure 2.2



Figure 2.1 and 2.2: Motor Grader with roof mounted dual rotating halogen beacons, slow moving vehicle sign, and caution signage.



City of Winnipeg, Public Works Department
Human Resource Division - Safety Branch

Hazard Categories (continued)

Level 3

- Equipment that falls under Level 3 includes, but is not limited to, equipment and passenger vehicles that may be used to enter construction or work zones, examples are:
 - Cars, Vans (excludes those used solely for administrative purposes)
 - Foreman's Trucks (Figure 3.0 and 3.1)
 - Out-front Lawnmowers
 - Skid Steer Loaders
 - Cement Trucks
- Equipment Visibility **Must** include
 - 360° visibility amber beacon light or equivalent
 - 4-way hazard lights



Figure 3.0



Figure 3.1



Figure 3.2



Figure 3.3

Smaller beacons (Figure 3.3) or equivalent such as a 360° LED strobe light may be used on the smaller units (i.e. All terrain vehicles, skid steers or out front mowers, etc)

NOTE - Vehicles typically traveling at a speed less than 40 kilometers per hour **must** be equipped with a slow moving vehicle sign (Figure 3.3) indicating that it is a slow moving vehicle in compliance with the Highway Traffic Act. (See Appendix I)



City of Winnipeg, Public Works Department
Human Resource Division - Safety Branch

Hazard Categories (continued)

Level 4

- Equipment that falls under Level 4 includes, but is not limited to, units that are not self-propelled (trailers and equipment) and are normally working in a signed or flagged work zone and are attached to other units equipped with beacons, these may include
 - Caboose (work trailer)
 - Compressor
 - Tar Kettle
- Equipment Visibility **Must** include
 - Retro-reflective striping visible on all sides including the trailer tongue
- Towed units that obstruct the towing vehicles tail lights **must** be equipped with tail lights/signal lights as per the Highway Traffic Act. Directional Lighting may be added (Figure 4.2).
- Trailers and attachments not designed to be towed over 40 kilometers per hour **MUST** display a slow moving vehicle sign (Figure 4.3). Especially important when the attachment obscures the towing equipment's slow moving vehicle sign (Appendix I).



Figure 4.0



Figure 4.1



Figure 4.2



Figure 4.3



City of Winnipeg, Public Works Department
Human Resource Division - Safety Branch

Lighting/Mounting Locations and Standards

Daytime Running Lights

All vehicles with a Risk Level of 1 to 3 must maintain daytime running lights that comply with the *Motor Vehicle Safety Act* (Canada). (See Appendix I)

Beacons

Mounted in such a way that 360° visibility is achieved. If this is not possible with one beacon, additional beacons must be added to achieve 350° visibility. If this is not possible with a beacon alone then supplemental lighting must be used. This supplemental lighting may include additional beacons and/or strobes until 360° visibility is effectively achieved (See Appendix II)

- Protective cages enclosing the beacons are recommended but not required, provided they do not impede the efficiency of the beacon or alter the structural integrity of the vehicle

Minimum Requirement for Beacons/Strobes

- For all new installations lighting equipment must meet or exceed **SAE J845 Class 2(2007)**
Or
- Previously installed equipment lighting must meet or exceed **SAE J1318 Class 2**

An LED beacon or equivalent is recommended for all new installations(LED recommended due to the dependability and high visibility). They must be able to either rotate, oscillate, pulsate, flash or light intermittently. They must be clearly distinguishable by an approaching motorist at a distance of at least 500 metres (0.5 km) on a bright sunny day.

Reflective Striping (Conspicuity Tape)

Mounted on all sides of the vehicle that faces the flow of traffic and where the vehicle width is 2032mm (80 in.) or wider AND GVWR 4536 kg (10,000 lb.) or more (See Appendix II). All trailers must have retro-reflective tape on all sides.

Requirements of Flashing or Sequential Arrow Traffic Control Devices

The Manual of Temporary Traffic Control (MTTC, 2011 edition) references traffic control devices, see Vehicle Mounted Flashing or Sequential Arrow Traffic Control Device for correct use of Directional lighting. A copy of the MTTC can purchased for a nominal fee at Public Works Customer Service, front desk at 1155 Pacific Avenue Winnipeg, MB. or a copy can be printed from the following link: http://winnipeg.ca/publicworks/InformationAndResources/TrafficControl/manual_of_temp_traffic_control.asp

Special Mobile Machines

A special mobile machine or other vehicle owned or operated by the government or a municipality and being used in snow removal operations shall be equipped with one or more lamps. (Appendix I) Vehicles, up to and including 1 ton trucks, used in snow clearing operations will not be required to be equipped with rear facing strobe lights. These vehicles do require 360° HVL. **Light fleet vehicles (up to 1 tons) engaged in truck plowing in parking lots and Park roadways must not display Blue Beacons.**

Compliance Schedule

All City of Winnipeg vehicles and equipment as well as equipment supplied by organizations under contract with the City of Winnipeg's Public Works Department must meet the Equipment Lighting/Visibility requirements as outlined in this document.

Cement Mixers are new additions and have a compliance date of: October 1, 2012



City of Winnipeg, Public Works Department
Human Resource Division - Safety Branch

Appendix I – Excerpts from The Highway Traffic Act

MINIMUM LIGHTING EQUIPMENT REQUIRED

Lighting equipment of vehicles

35(1) Except as otherwise provided in this Act, every vehicle shall, at all times while it is upon a highway, be equipped with lamps and other equipment in good working order as in this section provided, namely:

(n) Every motor vehicle manufactured on or after December 1, 1989, other than a motorcycle or moped, shall carry daytime running lights that comply with the standards prescribed for such lights by the regulations made under the *Motor Vehicle Safety Act* (Canada), and any motor vehicle manufactured before that date, other than a motorcycle or moped, may carry daytime running lights that comply with the standards approved for such lights by the Canadian Standards Association.

Lamps on repair and escort motor vehicles (Figure A1)

35(15) Notwithstanding subsection 38(1), a motor vehicle that is used

(a) by a repairer or a person engaged in the business of towing vehicles, or in connection with the repair or removal of damaged or disabled vehicles; or

(b) to escort oversized vehicles or loads as required by a permit issued therefore under the regulations;

shall be equipped with at least one lamp on its top that is capable of emitting an amber or a yellow light and that has a flashing or oscillating beam clearly visible under normal atmospheric conditions, when illuminated, from all directions for a distance of 150 metres, and, where the motor vehicle is being operated on a highway at a speed in excess of 80 kilometres an hour, clearly visible under normal atmospheric conditions, when illuminated, from all directions for a distance of one kilometre.

Figure A1



Directional Arrows and beacon/strobe for increased visibility, used as a blocking/shadowing vehicle



**City of Winnipeg, Public Works Department
Human Resource Division - Safety Branch**

Appendix I – Excerpts from The Highway Traffic Act (continued)

Lamps on special mobile vehicles (Figure A2)

35(16) A special mobile machine or other vehicle owned or operated by the government or a municipality and being used in snow removal operations shall be equipped with one or more lamps

(a) which, if there is only one, shall show a blue or amber light; and

(b) some of which, if there are two or more, shall show a blue light and some of which shall show an amber light;

and the lamps, in either case, shall have a flashing or oscillating beam and shall be of such size, candle power, and design as may be approved by the traffic board.

Figure A2



Motor Grader with Dual Rotating Strobe lights, where blue is active only during Winter snow removal

Lamps on special government or municipal vehicles

35(17) A special mobile machine or other vehicle owned or operated by the government or a municipality and being used in the maintenance or construction of roads or the collection of refuse may be equipped with a lamp or lamps which show an amber light, and the lamp or lamps shall have a flashing or oscillating beam and shall be of such size, candle power, and design as may be approved by the traffic board.

Special permits

37(6) A motor vehicle may be equipped with lighting equipment prohibited under subsection 38(1) if the owner thereof has, upon written application, obtained from the registrar a permit for the purpose specifying the lighting equipment authorized thereby, and stating the conditions, if any, under which it may be used; but the registrar may issue the permit only if, in his absolute discretion, he is satisfied

(a) that the circumstances in which the lighting equipment applied for is required are of such a special and unusual character that it is not in the public interest to refuse to issue the permit; and

(b) that the owner of the vehicle will use the lighting equipment, or cause it to be used, with due regard to the public safety



City of Winnipeg, Public Works Department
Human Resource Division - Safety Branch

Appendix I – Excerpts from The Highway Traffic Act (continued)

Prohibited lamps

38(1) Except as otherwise provided in this Act, the regulations or the *Motor Vehicle Safety Act* (Canada), or when authorized by permit under subsection 37(6) or (7), a motor vehicle on a highway shall not be equipped with

- (a) more than five lamps of over four candle power (of which not more than four are headlamps) on the front of, or visible from in front of, the vehicle; or
- (b) any search light or any lamp other than a stationary lamp; or
- (c) any lamp
 - (i) that casts a light of a colour other than white, or
 - (ii) that lights intermittently or in flashes; or
- (d) any lamp casting a light of over four mean spherical candle power unless it is so constructed, arranged, and adjusted, that no portion of the parallel beams of reflected light, when measured 25 metres or more ahead of the lamp, rises above 1.07 metres from the level surface on which the vehicle stands, as those heights are determined while the vehicle is fully loaded.

Lighting Equipment on Certain Vehicles

Certain utility vehicles

38.1(7) A vehicle owned by Manitoba Hydro, The Manitoba Telephone System or The City of Winnipeg that is equipped or designed for overhead wire construction or repair work may be equipped with one or more amber lamps that rotate, oscillate, pulsate, flash or light intermittently.

NOTE- The Highway Traffic Act prohibits any flashing, strobing or rotating lights on a motor vehicle other than signal lights. As such, beacons are prohibited on all motor vehicles in any color with the exception of specialty vehicles. As such, there is an allowance for the registrar to issue permits for having these kinds of lights. Permits can be obtained from Vehicle Standards and Inspection of MPI.

A permit for beacons must be carried in the vehicle at all times. An permit application is found on page 14 of this document.

City of Winnipeg vehicles are not required to carry a permit for beacons but must comply with the standards outlined in this document.



City of Winnipeg, Public Works Department
Human Resource Division - Safety Branch

Appendix I – Excerpts from The Highway Traffic Act (continued)

Warning device on slow vehicles

178(1) Subject to subsection (2), no person shall drive or operate on a highway any vehicle travelling at a speed less than 40 kilometers per hour unless there is displayed on the back thereof a reflectorized warning device of a type approved by the traffic board indicating that it is a slow moving vehicle, or the vehicle is permitted to be equipped with, and is equipped with, a lamp that emits an amber light and that lights intermittently or flashes, and the lamp is in operation and the light there from is visible from the rear.

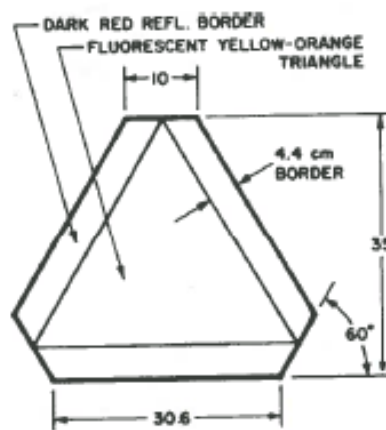

NOTE – Slow Moving Vehicle signs significantly increase rearward equipment visibility and also help to ensure that equipment remains operational during daylight hours in the event that a beacon or other HVL fails. Slow moving vehicles working for/with the City of Winnipeg's Public Works Department are to be equipped with both HVL and slow moving vehicle signs.



City of Winnipeg, Public Works Department
Human Resource Division - Safety Branch

Appendix II

Conspicuity Tape - To be used when the vehicle width is 2032mm (80 in.) or wider AND GVWR 4536 kg (10,000 lb.) or more (See Figure A and B)



Figure A



Figure B

Motor Vehicle Safety Regulations
Conspicuity Systems - Section S5.7 of TSD 108

(21) Notwithstanding section S5.7 of TSD (Technical Standards Document) 108, the color of retro reflective sheeting applied to a vehicle pursuant to paragraphs S5.7.1.4.1(a) and S5.7.1.4.2 of TSD 108 may be white, yellow, white and yellow or white and red, in accordance with the paragraph S5.7.1.2 of TSD 108 or paragraphs 3.1.3, 3.1.2 and 3.1.1 of SAE Standard J578. (See Table 1 and Figures C to H)

Table 1

Width 2032mm (80 in.) or wider AND GVWR 4536 kg (10,000 lb.) or more

DESCRIPTION	MANDATORY REQUIREMENTS							
	Area	Conspicuity Treatment	DOT Coding	Quantity	Color	Location	Height	Options
9	Rear Upper Body Markings	DOT-C DOT-C2 DOT-C3 DOT-C4		Exactly 2 pairs of 300mm long strips	White	On the rear upper corners facing rearward	At the top	Retro reflectors may not be required if they are replaced in their required location with conspicuity treatment. Optional in Canada: Rear lower body and side conspicuity treatment may also be solid white, solid yellow, or white and yellow
10	Bumper Bar Marking			Continuous	Red/White	On the rear bumper bar's horizontal element full width - facing rearward	No requirement	
11	Rear Lower Body Marking			Continuous	Red/White (see options)	On the rear full width of the vehicle facing rearward	As horizontal as practicable and as close as practicable to the range of 375 to 1525mm from the ground	
12	Side Marking		(see location)		Red/White (see options)	Each side - facing sideward continuous, or evenly spaced over minimum of 50% of length starts and ends as close to the front and rear of the vehicle as practicable	As horizontal as practicable and as close as practicable to the range of 375 to 1525mm from the ground	
<p><i>NOTE: The edge of red conspicuity tape shall not be closer than 75 mm to the edge of any amber lamp and the edge of white conspicuity tape shall not be closer than 75 mm to the edge of any lamp</i></p>								



City of Winnipeg, Public Works Department
Human Resource Division - Safety Branch

Appendix II (continued)



Figure C

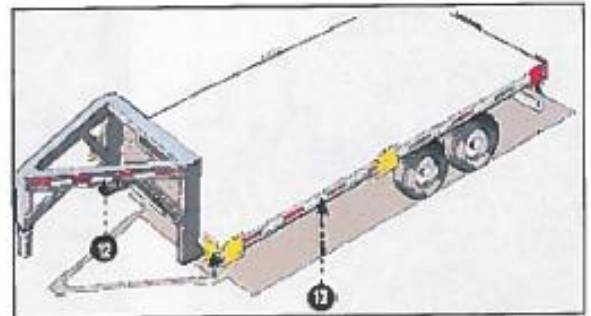

Figure D

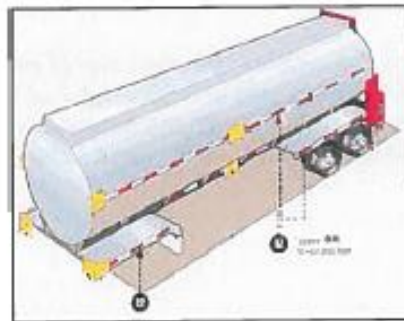

Figure E

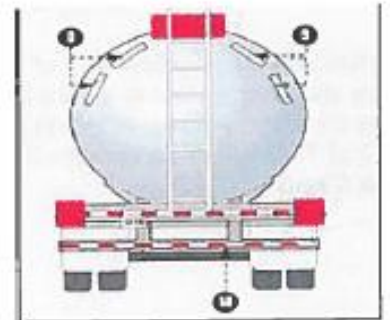

Figure F

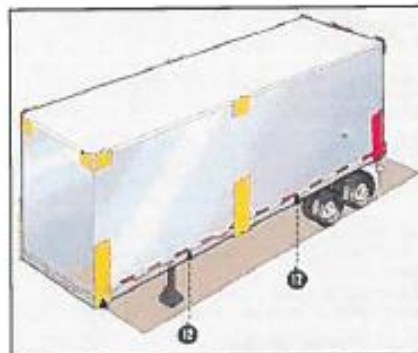

Figure G

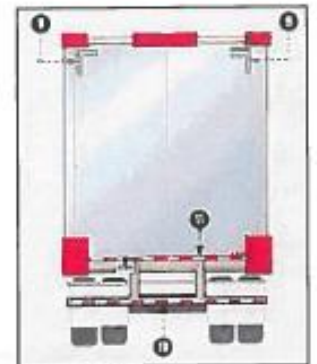

Figure H



Public Works Department
Human Resource Division, Safety Branch

Appendix III-Rear Facing Strobes

Strobe lights facing rear

Figure A3-1



Beacon centered on lip of box with protective cage (recommended), providing 360° visibility in combination with strobe lights amber and blue on rear of vehicle (blue - snow removal operations only)

Figure A3-2



Double beacons mounted on lip of box with protective cage (recommended), providing 360° visibility (blue - snow removal operations only) – blue lens and/or beacon to be de-energized for all non snow removal operations

Figure A3



Amber Strobe light at top, with brake/signal/backup light array in side configuration

Figure A3-4

